

CE EMC Test Report

Report No.: CE171204D06

Test Model: ECS-4000-2R

Series Model: ECS-4XXXXXXXXXXXX
(“X” can be 0-9, A-Z or blank for marketing purpose)

Received Date: Dec. 4, 2017

Test Date: Dec. 15, 2017 ~ Jan. 5, 2018

Issued Date: Jan. 15, 2018

Applicant: Vecow Co., Ltd.

Address: 12F., No. 111, Zhongcheng Rd., Tucheng Dist., New Taipei City 23674
Taiwan (R. O. C.)

Issued By: Bureau Veritas Consumer Products Services (H.K.) Ltd., Taoyuan Branch

Lab Address: No. 47-2, 14th Ling, Chia Pau Vil., Lin Kou Dist., New Taipei City, Taiwan
(R.O.C.)



This report is for your exclusive use. Any copying or replication of this report to or for any other person or entity, or use of our name or trademark, is permitted only with our prior written permission. This report sets forth our findings solely with respect to the test samples identified herein. The results set forth in this report are not indicative or representative of the quality or characteristics of the lot from which a test sample was taken or any similar or identical product unless specifically and expressly noted. Our report includes all of the tests requested by you and the results thereof based upon the information that you provided to us. You have 60 days from date of issuance of this report to notify us of any material error or omission caused by our negligence, provided, however, that such notice shall be in writing and shall specifically address the issue you wish to raise. A failure to raise such issue within the prescribed time shall constitute your unqualified acceptance of the completeness of this report, the tests conducted and the correctness of the report contents. Unless specific mention, the uncertainty of measurement has been explicitly taken into account to declare the compliance or non-compliance to the specification. The report must not be used by the client to claim product certification, approval, or endorsement by A2LA, or any agency of the federal government. The report must not be used by the client to claim product certification, approval, or endorsement by TAF or any government agencies.

Table of Contents

Release Control Record	4
1 Certificate of Conformity	5
2 Summary of Test Results	6
3 General Information	8
3.1 Features of EUT	8
3.2 General Description of EUT	8
3.3 Operating Modes of EUT and Determination of Worst Case Operating Mode	9
3.4 Test Program Used and Operation Descriptions.....	9
4 Configuration and Connections with EUT	10
4.1 Connection Diagram of EUT and Peripheral Devices.....	10
4.2 Configuration of Peripheral Devices and Cable Connections	12
5 Conducted Emissions Measurement	14
5.1 Limits	14
5.2 Test Instruments	14
5.3 Test Arrangement	15
5.4 Test Results	16
6 Radiated Emissions from enclosure port	18
6.1 Limits	18
6.2 Test Instruments	19
6.3 Test Arrangement	20
6.3.1 Radiated emissions test arrangement for 150 kHz – 30 MHz:.....	20
6.3.2 Radiated emissions test arrangement for 30 MHz – 1000 MHz:.....	21
6.3.3 Radiated emissions test arrangement for 1000 MHz – 2000 MHz:.....	22
6.4 Test Results	23
6.5 Performance Criteria	31
7 Immunity to Conducted Radio Frequency disturbance (CS)	32
7.1 Test Specification.....	32
7.2 Test Instruments	32
7.3 Test Arrangement	33
7.4 Test Results	35
8 Radiated, Radio-frequency, Electromagnetic Field Immunity Test (RS)	36
8.1 Test Specification.....	36
8.2 Test Instruments	36
8.3 Test Arrangement	37
8.4 Test Results	38
9 Electrical Fast Transient/Burst Immunity Test (EFT)	39
9.1 Test Specification.....	39
9.2 Test Instruments	39
9.3 Test Arrangement	40
9.4 Test Results	41
10 Power supply failure	42
10.1 Test Specification.....	42
10.2 Test Instruments	42
10.3 Test Arrangement	42
10.4 Test Results	43
11 Electrostatic Discharge Immunity Test (ESD)	44

11.1	Test Specification.....	44
11.2	Test Instruments	44
11.3	Test Arrangement	45
11.4	Test Results	46
12	Pictures of Test Arrangements	49
12.1	Conducted Emissions.....	49
12.2	Radiated Emissions.....	50
12.3	Conducted Radio Frequency Disturbance (CS).....	52
12.4	Radiated disturbance (RS).....	53
12.5	Burst / Fast Transient (EFT).....	54
12.6	Power supply failure	55
12.7	Electrostatic Discharge Immunity Test (ESD)	55
Appendix – Information on the Testing Laboratories		56

Release Control Record

Issue No.	Description	Date Issued
CE171204D06	Original release.	Jan. 15, 2018

1 Certificate of Conformity

Product: Box PC
Brand: Vecow
Test Model: ECS-4000-2R
Series Model: ECS-4XXXXXXXXXX ("X" can be 0-9, A-Z or blank for marketing purpose)
Sample Status: Engineering sample
Applicant: Vecow Co., Ltd.
Test Date: Dec. 15, 2017 ~ Jan. 5, 2018
Standards: **EN 60945:2002, clause 9, 10**
IEC 61000-4-2:2008 ED. 2.0
IEC 61000-4-3:2010 ED. 3.2
IEC 61000-4-4:2012 ED. 3.0
IEC 61000-4-5:2014 ED. 3.0 (Not applicable)
IEC 61000-4-6:2013 ED. 4.0
IEC 61000-4-11:2004 ED. 2.0

The above equipment has been tested by **Bureau Veritas Consumer Products Services (H.K.) Ltd., Taoyuan Branch**, and found compliance with the requirement of the above standards. The test record, data evaluation & Equipment Under Test (EUT) configurations represented herein are true and accurate accounts of the measurements of the sample's EMC characteristics under the conditions specified in this report.

Prepared by :  , **Date:** Jan. 15, 2018
Celia Chen / Supervisor

Approved by :  , **Date:** Jan. 15, 2018
Henry Lai / Director

2 Summary of Test Results

EN 60945:2002						
Clause	Basic standard	Test parameters			Result/Remarks	Verdict
9.2	CISPR 16-1-1 CISPR 16-1-2	Conducted Emissions			Minimum passing margin is -8.63 dB at 13.29297 MHz	Pass
		Frequency range:	Limits:	Bandwidth / Detectors		
		10 – 150 kHz 150 - 350 kHz 350 kHz - 30 MHz	96 - 50 dB μ V 60 - 50 dB μ V 50 dB μ V	200 Hz / QP 9 kHz / QP 9 kHz / QP		
9.3	CISPR 16-1-1 CISPR 16-1-4	Radiated Emissions from Enclosure Port			Minimum passing margin is -1.12 dB at 771.46 MHz	Pass
		Frequency range:	Limits: @ 3m	Bandwidth / Detectors		
		0.15 - 0.3 MHz 0.3 - 30 MHz 30 - 2000 MHz except for: 156 -165 MHz	80 - 52 dB μ V/m 52 - 34 dB μ V/m 54 dB μ V/m 24 dB μ V/m or 30 dB μ V/m	9 kHz / QP 9 kHz / QP 120 kHz / QP 9 kHz / QP 9 kHz / peak		
10.3	IEC 61000-4-6	Conducted Radio Frequency disturbance a.c. and d.c. power ports, signal and control ports: Modulation: 80% AM at 400 Hz Amplitude: 3 V rms for frequency range: 150 kHz - 80 MHz 10 V rms at spot frequencies: 2, 3, 4, 6.2, 8.2, 12.6, 16.5, 18.8, 22, and 25 MHz. Performance Criterion A			Performance Criterion A	Pass
10.4	IEC 61000-4-3	Radiated disturbance, Enclosure port Frequency range: 80 MHz to 2 GHz Modulation: 80% AM at 400 Hz Field strength: 10V/m Performance Criterion A			Performance Criterion A	Pass
10.5	IEC 61000-4-4	Bursts/Fast Transients Rise time/width: 5/50 (T _r /T _h) ns Amplitude: 2kV differential on a.c. power lines, 2.5kHz 1kV common mode on signal and control lines, 5kHz Performance Criterion B			Performance Criterion A	Pass
10.6	IEC 61000-4-5	Surge / Slow transients AC Power ports: 1.2/50 (8/20) (T _r /T _h) μ s Line to line: \pm 0.5kV Line to earth: \pm 1Kv Performance Criterion B			Test not applicable because port does not exist	N/A
10.7	IEC 61000-4-11	Power supply short term variation: a.c. power ports			Test not applicable because port does not exist	N/A
		Voltage deviation transient (duration 1.5 s)	Frequency deviation transient (duration 5 s)			
		+20 % -20 %	+10 % - 10 %			
10.8	IEC 61000-4-11	Power supply failure: a.c. and d.c. power ports 60 s interruption Performance Criterion C			Performance Criterion C	Pass
10.9	IEC 61000-4-2	Electrostatic Discharge Contact discharge: 6kV Air discharge: 8kV Performance Criterion B			Performance Criterion B	Pass

Note:

- There is no deviation to the applied test methods and requirements covered by the scope of this report.
- N/A: Not Applicable

2.1 Measurement Uncertainty

Where relevant, the following measurement uncertainty levels have been estimated for tests performed on the EUT as specified in CISPR 16-4-2:

The listed uncertainties are the worst case uncertainty for the entire range of measurement. Please note that the uncertainty values are provided for informational purposes only and are not used in determining the PASS/FAIL results.

Measurement	Expanded Uncertainty (k=2) (\pm)
Conducted disturbance at mains port using AMN, 9kHz ~ 150kHz	2.77 dB
Conducted disturbance at mains port using AMN, 150kHz ~ 30MHz	2.77 dB
Radiated disturbance, 9kHz ~ 30MHz	2.38 dB
Radiated disturbance, 30MHz ~ 1GHz	5.63 dB
Radiated disturbance, 1GHz ~ 2GHz	4.97 dB

The other instruments specified are routine verified to remain within the calibrated levels, no measurement uncertainty is required to be calculated.

2.2 Modification Record

There were no modifications required for compliance.

3 General Information

3.1 Features of EUT



The tests reported herein were performed according to the method specified by Vecow Co., Ltd., for detailed feature description, please refer to the manufacturer's specifications or user's manual.

3.2 General Description of EUT

Product	Box PC
Brand	Vecow
Test Model	ECS-4000-2R
Series Model	ECS-4XXXXXXXXXX ("X" can be 0-9, A-Z or blank for marketing purpose)
Model Difference	For marketing purpose
Sample Status	Engineering sample
Operating Software	Windows 7
Power Supply Rating	6V to 36V, DC-in
Accessory Device	N/A
Data Cable Supplied	N/A

Note:

1. The EUT is a Box PC with the following interfaces.

<ul style="list-style-type: none"> ✧ USB 2.0*2 ✧ USB 3.0*2 ✧ SIM card socket*2 ✧ CFast card socket ✧ DVI-D (resolution Up to 1920 x 1080, 60Hz) ✧ Display*2 (resolution Up to 4K, 60Hz) ✧ LAN*2 (10/100/1000Mbps) 	
<ul style="list-style-type: none"> ✧ Mic. in ✧ Line out ✧ COM*6 (RS-232/ RS-422/ RS-485) ✧ Isolated DIO (20 Isolated DIO : 10 DI, 10 DO) ✧ USB 2.0*1 ✧ DC input 	

✘ As per client's requirement, the SIM card reader was not installed any SIM card during the test.

2. The EUT was configured with the following key components:

Component	Brand	Model No. or P/N	Spec.
CPU	Intel	i7-5650U	3.2GHz
Memory	Kingston	99U5428-018.A00LF	8GB DDR3L 1600MHz
SATA HDD	HGST	HTS545050A7E680	500GB 5400RPM

3. The EUT uses following adapter for the test (provided by client, for support units only).

Brand	FSP
Model	FSP120-AABN2
Input Power	100-240Vac, 1.8A, 50-60Hz
Output Power	24Vdc, 5A
Power Line	Non-shielded DC (1.4m) with one ferrite core

3.3 Operating Modes of EUT and Determination of Worst Case Operating Mode

Test modes are presented in the report as below.

Mode	Test Condition	Input Power
Conducted emission test		
1	Full system (SIM card function excluded)	230Vac/ 50Hz (adapter)
Radiated emission test		
1	Full system (SIM card function excluded)	24Vdc
Immunity tests		
1	Full system (SIM card function excluded)	24Vdc

3.4 Test Program Used and Operation Descriptions

Emission tests:

- a. Turned on the power of all equipment.
- b. EUT ran a test program to enable all functions.
- c. EUT read and wrote messages from/to card reader, internal HDD and external HDDs.
- d. EUT sent and received messages to/from Notebook PCs (kept in a remote area) via two UTP LAN cables (10m each).
- e. EUT sent "H" messages to ext. LCD Monitors. Then they displayed "H" patterns on their screens simultaneously.
- f. EUT sent 1kHz audio signal to earphone.
- g. EUT sent messages to printer and printer printed them out.
- h. EUT sent messages to modems.
- i. Steps c-h were repeated.

Immunity tests:

- a. Turned on the power of all equipment.
- b. EUT ran a test program to enable all functions.
- c. EUT read and wrote messages from/to card reader, internal HDD and external USB flash disks.
- d. EUT sent and received messages to/from Notebook PCs (kept in a remote area) via two UTP LAN cables (10m each).
- e. EUT sent "H" messages to ext. LCD Monitors. Then they displayed "H" patterns on their screens simultaneously.
- f. EUT sent audio signal to speaker.
- g. Steps c-f were repeated.

4 Configuration and Connections with EUT

4.1 Connection Diagram of EUT and Peripheral Devices

Emission tests:

TEST CONFIGURATION

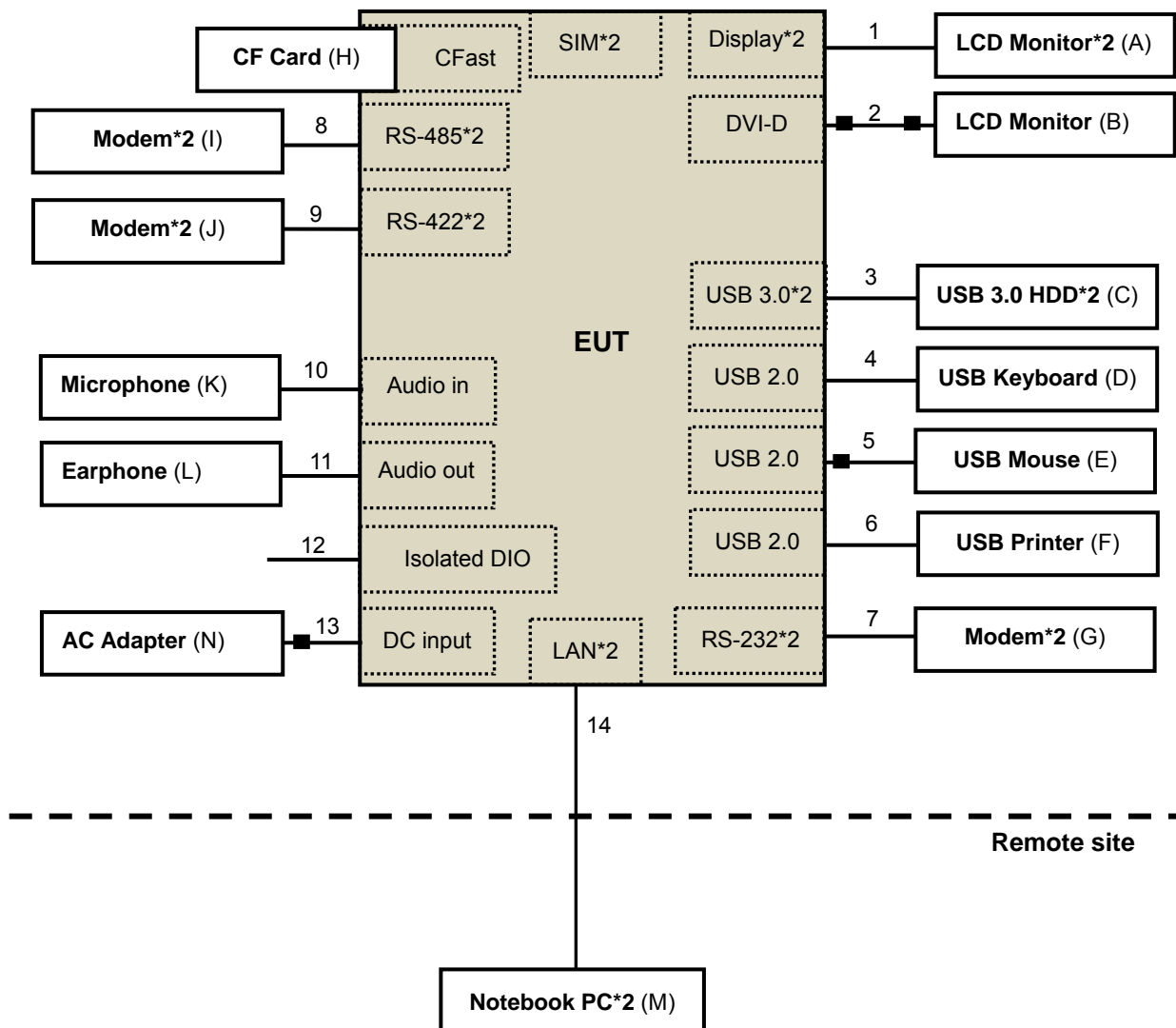

Immunity tests:

TEST CONFIGURATION

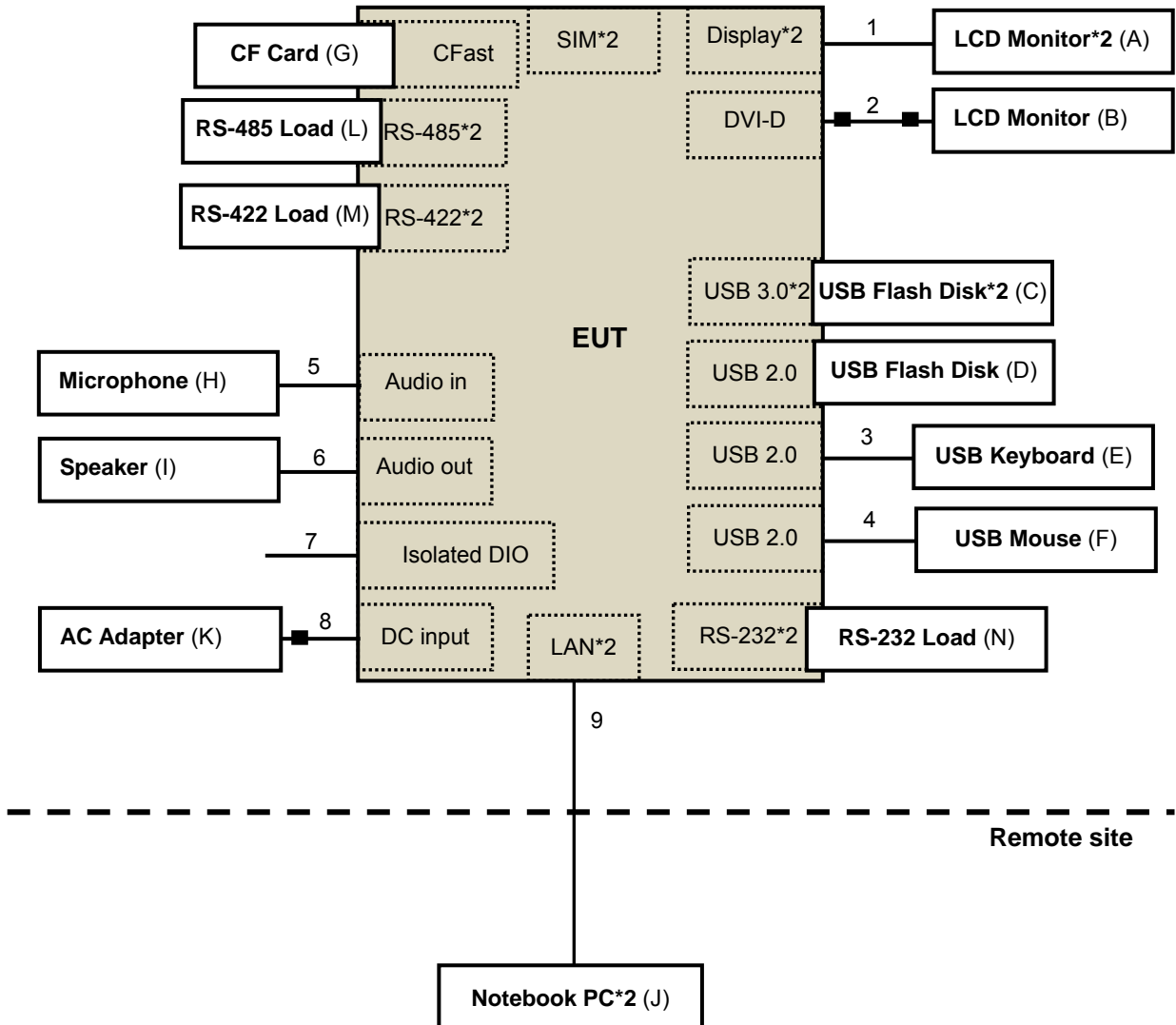

4.2 Configuration of Peripheral Devices and Cable Connections

Emission tests:

ID	Product	Brand	Model No.	Serial No.	FCC ID	Remarks
A.	LCD Monitor	HP	HP Z24s	6CM5172L56	FCC DoC Approved	Provided by Lab
	LCD Monitor	HP	HP Z24s	6CM5172L58	FCC DoC Approved	Provided by Lab
B.	24" LCD MONITOR	DELL	U2410	CN082WXD728720CC 0UHL	FCC DoC Approved	Provided by Lab
C.	USB 3.0 Hard Disk	WD	WDBUZG0010BBK-PESN	WX51E940FMSW	FCC DoC Approved	Provided by Lab
	USB 3.0 Hard Disk	WD	WDBUZG0010BBK-PESN	WXN1E94A9S8X	FCC DoC Approved	Provided by Lab
D.	USB KEYBOARD	BTC	5200U	G09302046353	E5XKB5122U	Provided by Lab
E.	USB Mouse	Microsoft	1113	9170515153471	FCC DoC Approved	Provided by Lab
F.	PRINTER	HP	HP Officejet Pro 251dw	CN57SCV0F1	FCC DoC Approved	Provided by Lab
G.	MODEM	ACEEX	1414	0206026747	IFAXDM1414	Provided by Lab
	MODEM	ACEEX	1414	0206026742	IFAXDM1414	Provided by Lab
H.	CF Card	INNODISK	CFast 3ME	N/A	N/A	Supplied by client
I.	MODEM	ACEEX	1414	980020505	IFAXDM1414	Provided by Lab
	MODEM	ACEEX	1414	980020504	IFAXDM1414	Provided by Lab
J.	MODEM	ACEEX	1414	980020538	IFAXDM1414	Provided by Lab
	MODEM	ACEEX	1414	980020526	IFAXDM1414	Provided by Lab
K.	MICROPHONE	Labtec	mic-333	N/A	N/A	Provided by Lab
L.	EARPHONE	PHILIPS	SBC HL145	N/A	N/A	Provided by Lab
M.	Notebook PC	ASUS	PU401L	ECNXBC012528528	FCC DoC Approved	Provided by Lab
	Notebook PC	SONY	SVS151A12P	275548477001024	FCC DoC Approved	Provided by Lab
N.	AC Adapter	FSP	FSP120-AABN2	N/A	N/A	Supplied by client

Note:

1. All power cords of the above support units are non-shielded (1.8m).
2. Item M acted as communication partners to transfer data.

ID	Descriptions	Qty.	Length (m)	Shielding (Yes/No)	Cores (Qty.)	Remarks
1.	Display cable	2	1.8	Y	0	Provided by Lab
2.	DVI cable	1	1.8	Y	2	Supplied by client
3.	USB cable	2	0.4	Y	0	Provided by Lab
4.	USB cable	1	1.5	Y	0	Provided by Lab
5.	USB cable	1	1.8	Y	1	Provided by Lab
6.	USB cable	1	1.5	Y	0	Provided by Lab
7.	RS232 cable	2	1.5	Y	0	Provided by Lab
8.	RS232 cable	2	1.5	Y	0	Provided by Lab
9.	RS232 cable	2	1.5	Y	0	Provided by Lab
10.	Audio cable	1	2.0	N	0	Provided by Lab
11.	Audio cable	1	1.5	N	0	Provided by Lab
12.	Data cable	2	0.5	N	0	Supplied by client
13.	DC cable	1	1.4	N	1	Supplied by client
14.	LAN cable (Cat.5e)	2	10	N	0	Provided by Lab

Note: The core(s) is(are) originally attached to the cable(s).

Immunity tests:

ID	Product	Brand	Model No.	Serial No.	FCC ID	Remarks
A.	LCD Monitor	DELL	U2413f	CN-06VNX5-72872-46 D-A88L	FCC DoC Approved	Provided by Lab
	LCD Monitor	DELL	P2415Qb	CN-OGTTPW-74261-6 62-OAGL	FCC DoC Approved	Provided by Lab
B.	LCD Monitor	DELL	2408WFP	CN0NN79274261823S 1DMS	FCC DoC Approved	Provided by Lab
C.	USB Flash Disk*2	HP	16GB	N/A	N/A	Provided by Lab
D.	USB Flash Disk	HP	16GB	N/A	N/A	Provided by Lab
E.	USB Keyboard	Microsoft	N/A	N/A	N/A	Provided by Lab
F.	USB Mouse	HP	M-UAE96	F93A90AN3V42GQ5	FCC DoC Approved	Provided by Lab
G.	CF Card	INNODISK	CFast 3ME	N/A	N/A	Supplied by client
H.	MICROPHONE	N/A	N/A	N/A	N/A	Provided by Lab
I.	Speaker	N/A	N/A	N/A	N/A	Provided by Lab
J.	Notebook PC	Lenovo	TP00057A	R9-0JMLFS16/01	FCC DoC Approved	Provided by Lab
	Notebook PC	Lenovo	L440	R90FCKH8	FCC DoC Approved	Provided by Lab
K.	AC Adapter	FSP	FSP120-AABN2	N/A	N/A	Supplied by client
L.	RS-485 Load	N/A	N/A	N/A	N/A	Provided by Lab
M.	RS-422 Load	N/A	N/A	N/A	N/A	Provided by Lab
N.	RS-232 Load	N/A	N/A	N/A	N/A	Provided by Lab

Note:

1. All power cords of the above support units are non-shielded (1.8m).
2. Item J acted as communication partners to transfer data.

ID	Descriptions	Qty.	Length (m)	Shielding (Yes/No)	Cores (Qty.)	Remarks
1.	Display cable	2	1.8	Y	0	Provided by Lab
2.	DVI cable	1	1.8	Y	2	Supplied by client
3.	USB cable	1	1.8	Y	0	Provided by Lab
4.	USB cable	1	1.8	Y	0	Provided by Lab
5.	Audio cable	1	1.0	N	0	Provided by Lab
6.	Audio cable	1	1.0	N	0	Provided by Lab
7.	Data cable	2	0.5	N	0	Supplied by client
8.	DC cable	1	1.4	N	1	Supplied by client
9.	LAN cable (Cat.5e)	2	3	N	0	Provided by Lab

Note: The core(s) is(are) originally attached to the cable(s).

5 Conducted Emissions Measurement

5.1 Limits

Frequency range:	Limits:	Bandwidth / Detectors
10 – 150 kHz	96 - 50 dB μ V	200 Hz / QP
150 - 350 kHz	60 - 50 dB μ V	9 kHz / QP
350 kHz - 30 MHz	50 dB μ V	9 kHz / QP

Notes: 1. The lower limit shall apply at the transition frequencies.
 2. The limit decreases linearly with the logarithm of the frequency in the range of 10kHz to 150kHz and 150kHz to 350kHz

5.2 Test Instruments

Description & Manufacturer	Model No.	Serial No.	Cal. Date	Cal. Due
ROHDE & SCHWARZ TEST RECEIVER	ESCS 30	838251/021	Nov. 1, 2017	Oct. 31, 2018
ROHDE & SCHWARZ Artificial Mains Network (For EUT)	ENV216	101195	May 2, 2017	May 1, 2018
LISN With Adapter (for EUT)	AD10	C03Ada-002	May 2, 2017	May 1, 2018
EMCO L.I.S.N. (For peripherals)	3825/2	9504-2359	Jul. 25, 2017	Jul. 24, 2018
SCHWARZBECK Artificial Mains Network (For EUT)	NNLK8129	8129229	May 9, 2017	May 8, 2018
Software	Cond_V7.3.7.4	NA	NA	NA
RF cable (JYEBAO) With 10dB PAD	5D-FB	Cable-C03-01	Sep. 19, 2017	Sep. 18, 2018
LYNICS Terminator (For EMCO LISN)	0900510	E1-01-300	Jan. 18, 2017	Jan. 17, 2018
LYNICS Terminator (For EMCO LISN)	0900510	E1-01-301	Jan. 18, 2017	Jan. 17, 2018
ROHDE & SCHWARZ Artificial Mains Network (For TV EUT)	ESH3-Z5	100220	Nov. 14, 2017	Nov. 13, 2018
LISN With Adapter (for TV EUT)	100220	N/A	Nov. 14, 2017	Nov. 13, 2018

Notes: 1. The calibration interval of the above test instruments is 12 months and the calibrations are traceable to NML/ROC and NIST/USA.
 2. The test was performed in Shielded Room No. 3.
 3. The VCCI Site Registration No. C-10274.
 4. Tested Date: Dec. 15, 2017

5.3 Test Arrangement

- The power input cables between the a.c. and the d.c. power ports of the EUT and the artificial mains network shall be screened and not exceed 0,8 m in length.
- The measuring equipment and EUT was mounted on, and bonded to, an earth plane of the shielded room with EUT being connected to the power mains through a line impedance stabilization network (LISN). Other support units were connected to the power mains through another LISN. The two LISNs provide 50 Ohm/ 50uH of coupling impedance for the measuring instrument.
- Both lines of the power mains connected to the EUT were checked for maximum conducted interference.
- The frequency range from 10kHz to 30MHz was searched. The test results of conducted emissions at mains ports are recorded of six worst margins for quasi-peak values against the limits at frequencies of interest unless the margin is 20 dB or greater.

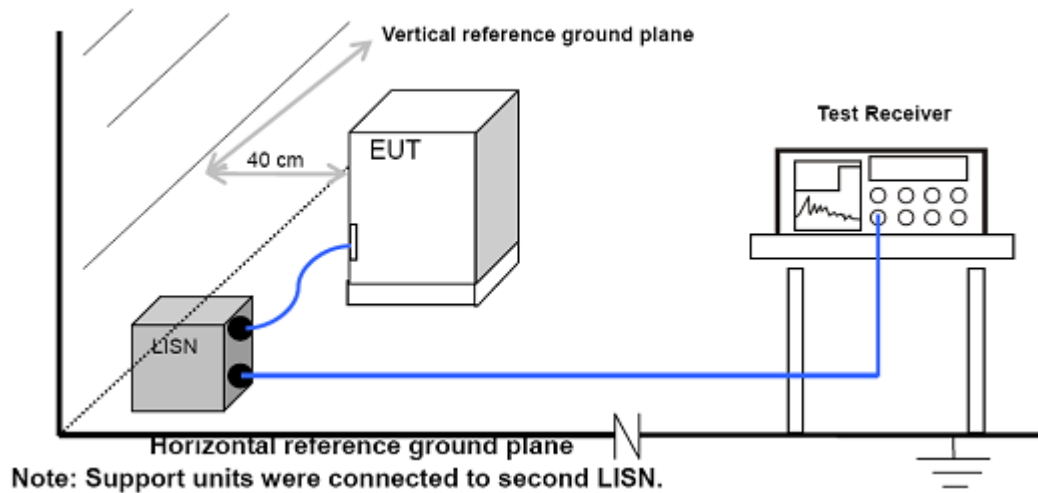

For the actual test configuration, please refer to the related item – Photographs of the Test Configuration.

5.4 Test Results

Frequency Range	10kHz ~ 150kHz; 150kHz ~ 30MHz	Detector Function & Bandwidth	Quasi-Peak (QP), 200Hz; Quasi-Peak (QP), 9kHz
Input Power	230Vac, 50Hz (Adapter)	Environmental Conditions	22°C, 76%RH
Tested by	Vhenson Huang		
Test Mode	Mode 1		

Phase Of Power : Line (L)						
No	Frequency (MHz)	Correction Factor (dB)	Reading Value (dBuV)	Emission Level (dBuV)	Limit (dBuV)	Margin (dB)
			Q.P.	Q.P.	Q.P.	Q.P.
1	0.02755	9.99	47.72	57.71	78.79	-21.08
2	0.04147	9.99	35.80	45.79	71.84	-26.05
3	0.04910	9.99	28.38	38.37	68.97	-30.60
4	0.05934	9.99	27.18	37.17	65.75	-28.58
5	0.14999	9.97	7.08	17.05	50.00	-32.95
6	0.16172	9.97	27.67	37.64	59.11	-21.47
7	0.41172	9.96	27.92	37.88	50.00	-12.12
8	13.29297	10.35	31.02	41.37	50.00	-8.63

Remarks:

1. The emission levels of other frequencies were very low against the limit.
2. Margin value = Emission level – Limit value
3. Correction factor = Insertion loss + Cable loss
4. Emission Level = Correction Factor + Reading Value



Frequency Range	10kHz ~ 150kHz; 150kHz ~ 30MHz	Detector Function & Bandwidth	Quasi-Peak (QP), 200Hz; Quasi-Peak (QP), 9kHz
Input Power	230Vac, 50Hz (Adapter)	Environmental Conditions	22°C, 76%RH
Tested by	Vhenson Huang		
Test Mode	Mode 1		

Phase Of Power : Neutral (N)						
No	Frequency (MHz)	Correction Factor (dB)	Reading Value (dBuV)	Emission Level (dBuV)	Limit (dBuV)	Margin (dB)
			Q.P.	Q.P.	Q.P.	Q.P.
1	0.02896	9.98	48.70	58.68	77.94	-19.26
2	0.04458	9.98	39.86	49.84	70.61	-20.77
3	0.06025	9.98	25.72	35.70	65.49	-29.79
4	0.14999	9.96	7.52	17.48	50.00	-32.52
5	0.15002	9.96	29.34	39.30	60.00	-20.70
6	1.43359	10.01	24.31	34.32	50.00	-15.68
7	13.33203	10.38	25.86	36.24	50.00	-13.76

Remarks:

1. The emission levels of other frequencies were very low against the limit.
2. Margin value = Emission level – Limit value
3. Correction factor = Insertion loss + Cable loss
4. Emission Level = Correction Factor + Reading Value

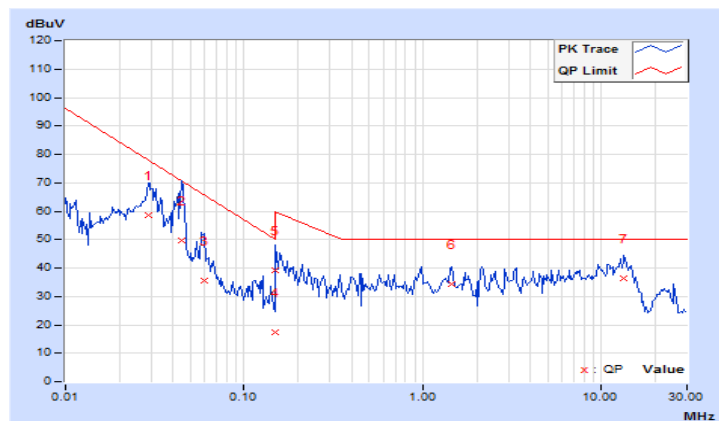

6 Radiated Emissions from enclosure port

6.1 Limits

Frequency range:	Limits: @ 3m	Bandwidth / Detectors
0.15 - 0.3 MHz	80 - 52 dB μ V/m	9 kHz / QP
0.3 - 30 MHz	52 - 34 dB μ V/m	9 kHz / QP
30 - 2000 MHz	54 dB μ V/m	120 kHz / QP
except for:		
156 -165 MHz	24 dB μ V/m or 30 dB μ V/m	9 kHz / QP 9 kHz / peak

- Notes:
1. The lower limit shall apply at the transition frequencies.
 2. Emission level (dB μ V/m) = 20 log Emission level (uV/m).
 3. All emanations from a digital device or system, including any network of conductors and apparatus connected thereto, shall not exceed the level of field strengths specified above.
 4. In addition, for the frequency band 156 MHz to 165 MHz, the measurement shall be repeated with a receiver bandwidth of 9 kHz, all other conditions remaining unchanged.
 5. Alternatively, for the frequency band 156 MHz to 165 MHz, a peak receiver or a frequency analyzer may be used, in accordance with the agreement between the manufacturer and the test house.

6.2 Test Instruments

For Frequency Range below 1000 MHz

Description & Manufacturer	Model No.	Serial No.	Cal. Date	Cal. Due
EMCI Preamplifier	EMC330H	980071	Feb. 21, 2017	Feb. 20, 2018
Agilent Test Receiver	N9038A	MY51210137	Jun. 23, 2017	Jun. 22, 2018
Schwarzbeck Antenna	VULB9168	9168-718	Dec. 06, 2017	Dec. 05, 2018
Max Full. Turn Table & Tower	MF7802	MF780208216	NA	NA
Software	Radiated_V8.7.08	NA	NA	NA
JYE BAO RF cable With 5dB PAD	8D	CABLE-CH10-01	May 23, 2017	May 22, 2018
EMCI Loop Antenna	LPA600	270	Aug. 11, 2017	Aug. 10, 2019
ADT. Turn Table	TT100	0306	NA	NA
ADT. Tower	AT100	0306	NA	NA

- Notes: 1. The calibration interval of the above test instruments is 12 months and the calibrations are traceable to NML/ROC and NIST/USA.
 2. The test was performed in Chamber No. 10.
 3. The Industry Canada Reference No. IC 7450E-11.
 4. Tested Date: Dec. 18, 2017

For Frequency Range above 1000 MHz

Description & Manufacturer	Model No.	Serial No.	Cal. Date	Cal. Due
Agilent Spectrum	E4446A	MY51100009	Jun. 1, 2017	May 31, 2018
Agilent Test Receiver	N9038A	MY51210137	Jun. 23, 2017	Jun. 22, 2018
Agilent Preamplifier	8449B	3008A01292	Feb. 22, 2017	Feb. 21, 2018
MITEQ Preamplifier	AMF-6F-260400-33-8P	892164	Feb. 21, 2017	Feb. 20, 2018
EMCI Preamplifier	EMC184045B	980235	Feb. 22, 2017	Feb. 21, 2018
Schwarzbeck Horn Antenna	BBHA-9170	212	Dec. 1, 2017	Nov. 30, 2018
EMCO Horn Antenna	3115	6714	Dec. 12, 2017	Dec. 11, 2018
Max Full. Turn Table	MF7802	MF780208216	NA	NA
Software	Radiated_V8.7.08	NA	NA	NA
SUHNER RF cable With 3/4dB PAD	SF102	Cable-CH10-3.6m	Aug. 14, 2017	Aug. 13, 2018
MICRO-TRONICS Notch filter	BRC50703-01	010	May 31, 2017	May 30, 2018
MICRO-TRONICS Band Pass Filter	BRM17690	005	May 31, 2017	May 30, 2018

- Notes: 1. The calibration interval of the above test instruments is 12 months and the calibrations are traceable to NML/ROC and NIST/USA.
 2. The 3dB beamwidth of the horn antenna is minimum 30 degree (or $w = 1.6m$ at 3m distance) for 1~6 GHz.
 3. The test was performed in Chamber No. 10.
 4. The Industry Canada Reference No. IC 7450E-11.
 5. The VCCI Site Registration No. G-10427
 6. Tested Date: Dec. 18, 2017

6.3 Test Arrangement

6.3.1 Radiated emissions test arrangement for 150 kHz – 30 MHz:

- The EUT was placed on the top of a rotating table 0.8 meters above the ground at an accredited test facility.
- The loop antenna is placed at a height of 1.5 m (center of loop) at a set distance of 3 m from the periphery of the EUT.
- Emissions reading in frequency range of 0.15 MHz to 30 MHz are measured using a Quasi-Peak detector.
- During the compliance scan, a number of variables should be altered in combination in order to *maximize* the emission for each frequency. The variables are:
 - *EUT Azimuth*. This is varied by rotating the turntable a full 360° for each frequency of interest.
 - *Antenna Azimuth*. Position the loop antenna vertically in all azimuths, record the maximum readings obtained.

Note: The resolution bandwidth and video bandwidth of test receiver/spectrum analyzer is 9kHz for quasi-peak detection (QP) at frequency up to 30MHz.

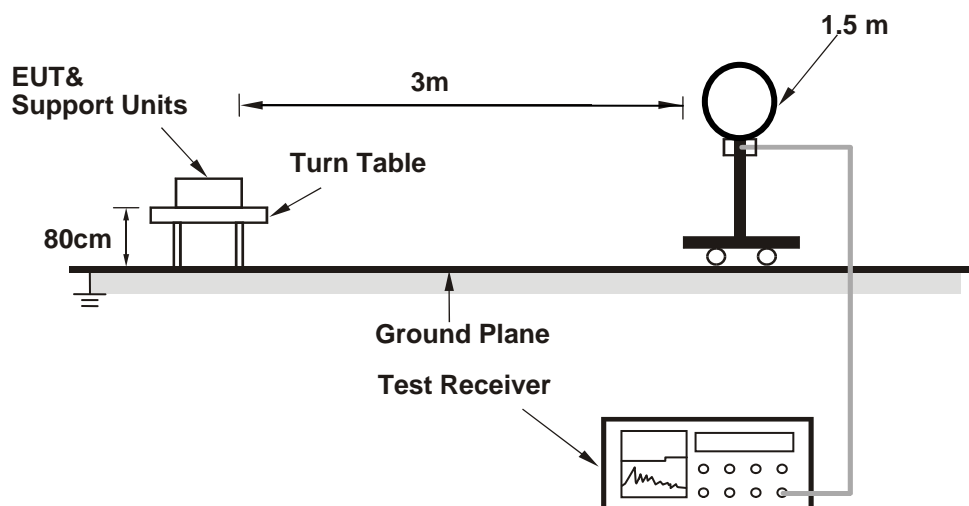

For the actual test configuration, please refer to the related item – Photographs of the Test Configuration.

6.3.2 Radiated emissions test arrangement for 30 MHz – 1000 MHz:

- The EUT was placed on the top of a rotating table 0.8 meters above the ground at an accredited test facility. The table was rotated 360 degrees to determine the position of the highest radiation.
- The EUT was set 3 meters away from the interference-receiving antenna, which was mounted on the top of a variable-height antenna tower.
- The antenna is a broadband antenna, and its height is varied from one meter to four meters above the ground to determine the maximum value of the field strength. Both horizontal and vertical polarizations of the antenna are set to make the measurement.
- For each suspected emission, the EUT was arranged to its worst case and then the antenna was tuned to heights from 1 meter to 4 meters and the rotatable table was turned from 0 degrees to 360 degrees to find the maximum reading.
- The test-receiver system was set to quasi-peak detect function and specified bandwidth with maximum hold mode when the test frequency is up to 1 GHz.

Note: The resolution bandwidth and video bandwidth of test receiver/spectrum analyzer is 120kHz for quasi-peak detection (QP) at frequency up to 1GHz.

In addition, for the frequency band 156 MHz to 165 MHz, the measurement shall be repeated with a receiver bandwidth of 9 kHz, all other conditions remaining unchanged. Alternatively, for the frequency band 156 MHz to 165 MHz, a peak receiver or a frequency analyzer may be used, in accordance with the agreement between the manufacturer and the test house.

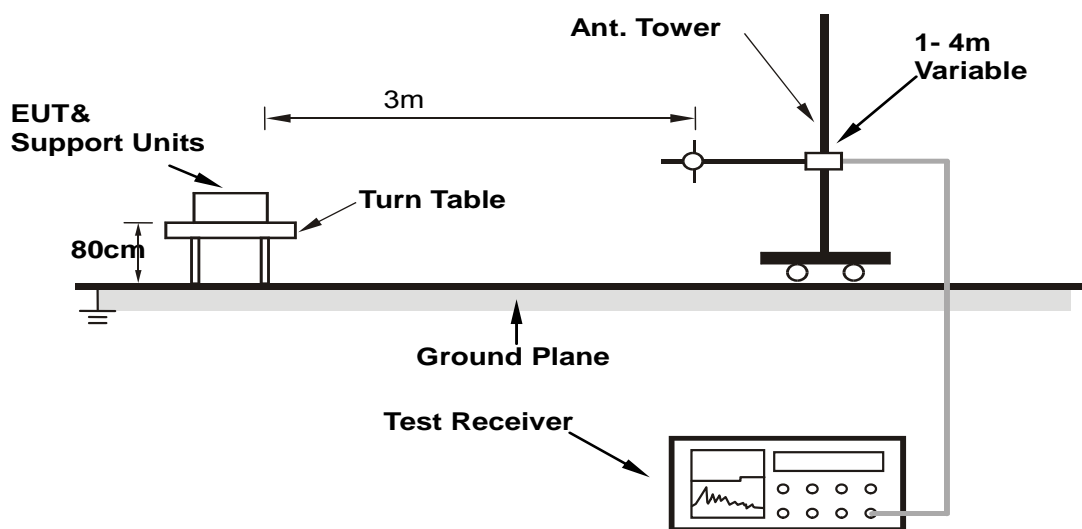

For the actual test configuration, please refer to the related item – Photographs of the Test Configuration.

6.3.3 Radiated emissions test arrangement for 1000 MHz – 2000 MHz:

- The EUT was placed on the top of a rotating table 0.8 meters above the ground at an accredited chamber room. The table was rotated 360 degrees to determine the position of the highest radiation.
- The EUT was set 3 meters away from the interference-receiving antenna, which was mounted on the top of a variable-height antenna tower.
- The height of antenna can be varied from one meter to four meters, the height of adjustment depends on the EUT height and the antenna 3dB beamwidth both, to detect the maximum value of the field strength. Both horizontal and vertical polarizations of the antenna are set to make the measurement.
- For each suspected emission, the EUT was arranged to its worst case and then the antenna was tuned to heights and the rotatable table was turned from 0 degrees to 360 degrees to find the maximum reading.
- The spectrum analyzer system was set to peak and average detects function and specified bandwidth with maximum hold mode when the test frequency is above 1 GHz.

Note: The resolution bandwidth of test receiver/spectrum analyzer is 1MHz and video bandwidth is 3MHz for quasi-peak detection (QP) at frequency above 1GHz.

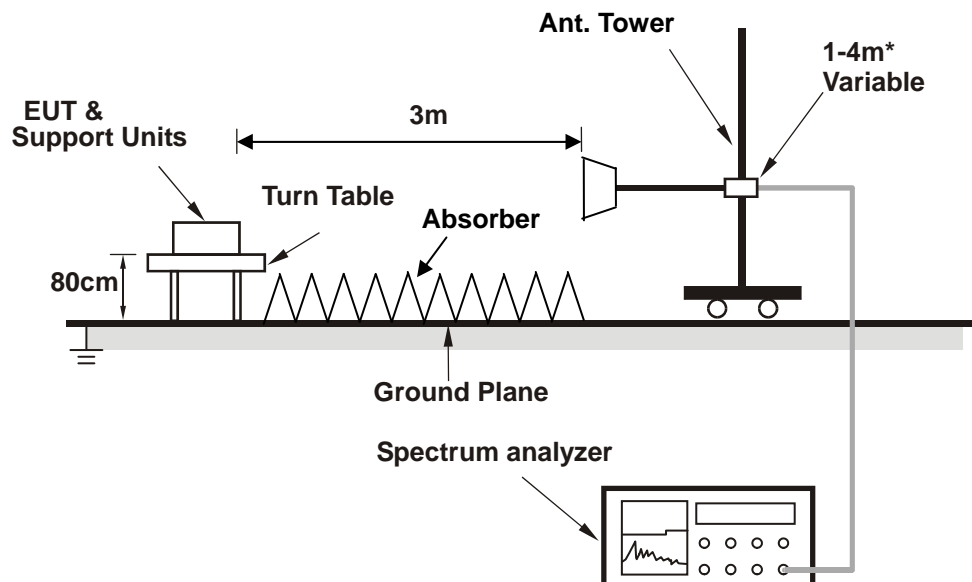

* :depends on the EUT height and the antenna 3dB beamwidth both.

For the actual test configuration, please refer to the related item – Photographs of the Test Configuration.

6.4 Test Results

Frequency Range	150kHz ~ 30MHz	Detector Function & Bandwidth	Quasi-Peak (QP), 9kHz
Input Power	24Vdc	Environmental Conditions	20°C, 80%RH
Tested by	ED. Lin		
Test Mode	Mode 1		

Antenna Polarity & Test Distance : Horizontal at 3 m

No	Frequency (MHz)	Emission Level (dBuV/m)	Limit (dBuV/m)	Margin (dB)	Antenna Height (m)	Table Angle (Degree)	Raw Value (dBuV)	Correction Factor (dB/m)
1	0.375	35.08 QP	51.13	-16.05	1.50 H	231	29.52	5.56
2	0.743	27.54 QP	48.46	-20.92	1.50 H	248	26.69	0.85
3	4.841	18.31 QP	41.13	-22.82	1.50 H	255	22.93	-4.62
4	6.442	21.19 QP	40.01	-18.82	1.50 H	316	26.01	-4.82
5	8.139	26.16 QP	39.10	-12.94	1.50 H	26	31.29	-5.13
6	29.836	20.95 QP	34.02	-13.07	1.50 H	69	26.81	-5.86

Remarks:

1. Emission Level(dBuV/m) = Raw Value(dBuV) + Correction Factor(dB/m)
2. Correction Factor(dB/m) = Antenna Factor (dB/m) + Cable Factor (dB)
– Pre-Amplifier Factor (dB)
3. The other emission levels were very low against the limit.
4. Margin value = Emission level – Limit value

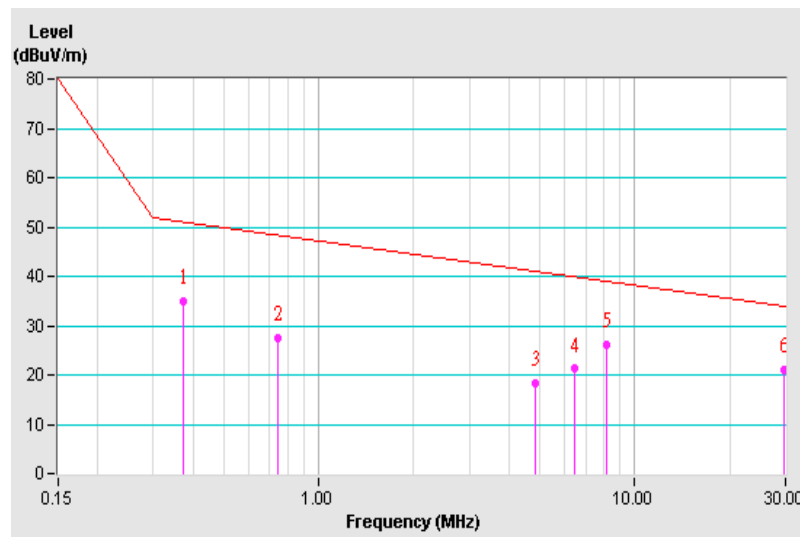

Frequency Range	150kHz ~ 30MHz	Detector Function & Bandwidth	Quasi-Peak (QP), 9kHz
Input Power	24Vdc	Environmental Conditions	20°C, 80%RH
Tested by	ED. Lin		
Test Mode	Mode 1		

Antenna Polarity & Test Distance : Vertical at 3 m								
No	Frequency (MHz)	Emission Level (dBuV/m)	Limit (dBuV/m)	Margin (dB)	Antenna Height (m)	Table Angle (Degree)	Raw Value (dBuV)	Correction Factor (dB/m)
1	0.312	37.23 QP	51.85	-14.62	1.50 V	83	30.32	6.91
2	0.424	31.14 QP	50.65	-19.51	1.50 V	218	26.50	4.64
3	1.216	23.01 QP	46.53	-23.52	1.50 V	174	24.42	-1.41
4	7.385	22.14 QP	39.48	-17.34	1.50 V	241	27.12	-4.98
5	13.727	26.49 QP	37.06	-10.57	1.50 V	213	32.58	-6.09
6	24.028	20.30 QP	34.87	-14.57	1.50 V	118	29.97	-9.67
7	27.205	22.08 QP	34.38	-12.30	1.50 V	111	30.47	-8.39
8	29.763	22.31 QP	34.03	-11.72	1.50 V	104	28.23	-5.92

Remarks:

1. Emission Level(dBuV/m) = Raw Value(dBuV) + Correction Factor(dB/m)
2. Correction Factor(dB/m) = Antenna Factor (dB/m) + Cable Factor (dB) – Pre-Amplifier Factor (dB)
3. The other emission levels were very low against the limit.
4. Margin value = Emission level – Limit value

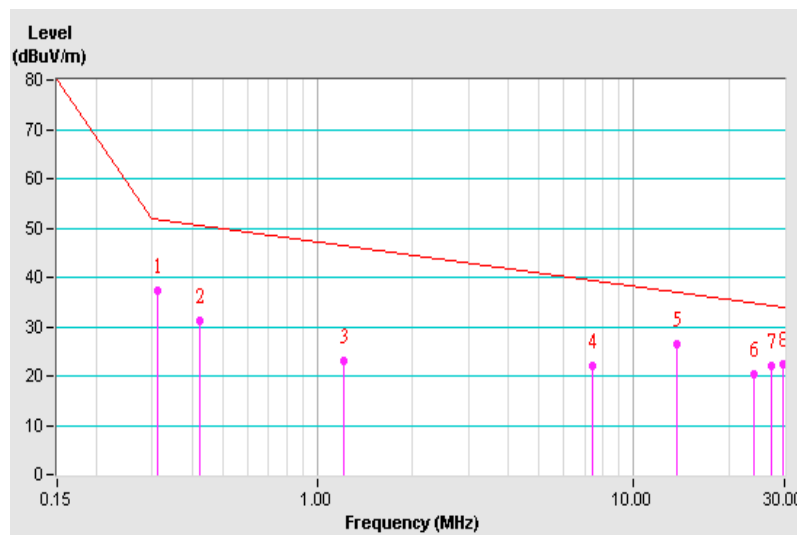

Frequency Range	30MHz ~ 1GHz	Detector Function & Bandwidth	Quasi-Peak (QP), 120kHz
Input Power	24Vdc	Environmental Conditions	20°C, 80%RH
Tested by	ED. Lin		
Test Mode	Mode 1		

Antenna Polarity & Test Distance : Horizontal at 3 m

No	Frequency (MHz)	Emission Level (dBuV/m)	Limit (dBuV/m)	Margin (dB)	Antenna Height (m)	Table Angle (Degree)	Raw Value (dBuV)	Correction Factor (dB/m)
1	152.58	40.28 QP	54.00	-13.72	2.04 H	0	53.95	-13.67
2	245.75	41.87 QP	54.00	-12.13	1.95 H	324	56.67	-14.80
3	308.58	51.32 QP	54.00	-2.68	1.00 H	322	63.72	-12.40
4	462.89	45.89 QP	54.00	-8.11	1.00 H	313	53.79	-7.90
5	617.19	45.35 QP	54.00	-8.65	1.05 H	172	49.50	-4.15
6	771.47	49.73 QP	54.00	-4.27	1.11 H	198	49.95	-0.22

Remarks:

1. Emission Level(dBuV/m) = Raw Value(dBuV) + Correction Factor(dB/m)
2. Correction Factor(dB/m) = Antenna Factor (dB/m) + Cable Factor (dB)
– Pre-Amplifier Factor (dB)
3. The other emission levels were very low against the limit.
4. Margin value = Emission level – Limit value

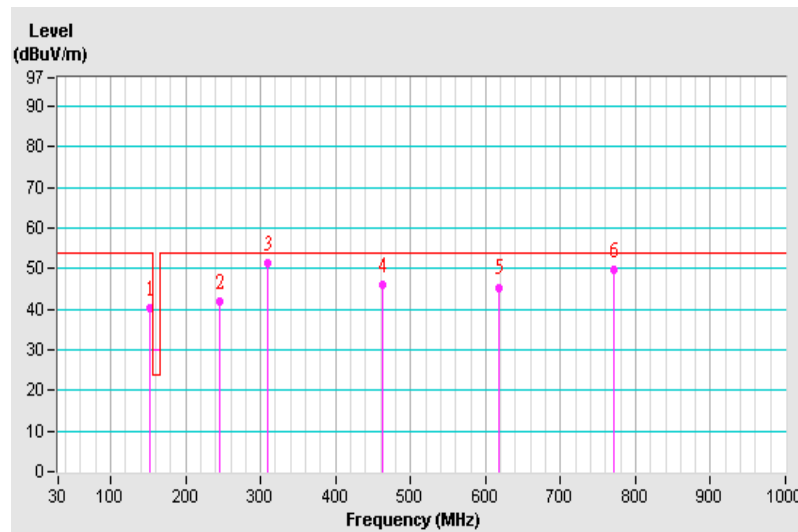

Frequency Range	30MHz ~ 1GHz	Detector Function & Bandwidth	Quasi-Peak (QP), 120kHz
Input Power	24Vdc	Environmental Conditions	20°C, 80%RH
Tested by	ED. Lin		
Test Mode	Mode 1		

Antenna Polarity & Test Distance : Vertical at 3 m								
No	Frequency (MHz)	Emission Level (dBuV/m)	Limit (dBuV/m)	Margin (dB)	Antenna Height (m)	Table Angle (Degree)	Raw Value (dBuV)	Correction Factor (dB/m)
1	30.39	40.20 QP	54.00	-13.80	1.00 V	111	55.66	-15.46
2	308.58	40.73 QP	54.00	-13.27	2.00 V	45	53.13	-12.40
3	480.01	37.63 QP	54.00	-16.37	1.00 V	317	45.33	-7.70
4	617.17	43.64 QP	54.00	-10.36	2.00 V	360	47.79	-4.15
5	771.46	52.88 QP	54.00	-1.12	1.00 V	1	53.10	-0.22
6	840.05	42.54 QP	54.00	-11.46	2.00 V	360	42.11	0.43

Remarks:

1. Emission Level(dBuV/m) = Raw Value(dBuV) + Correction Factor(dB/m)
2. Correction Factor(dB/m) = Antenna Factor (dB/m) + Cable Factor (dB)
– Pre-Amplifier Factor (dB)
3. The other emission levels were very low against the limit.
4. Margin value = Emission level – Limit value

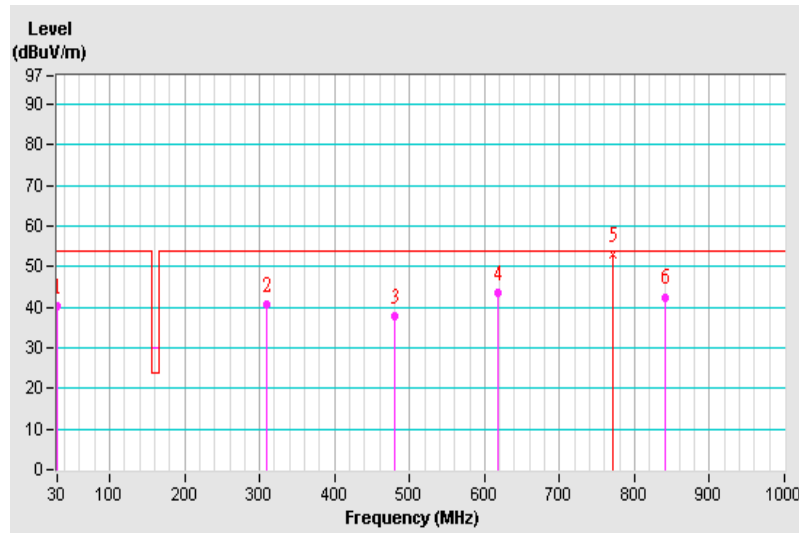

Frequency Range	1GHz ~ 2GHz	Detector Function & Bandwidth	Quasi-Peak (QP), 120kHz
Input Power	24Vdc	Environmental Conditions	20°C, 80%RH
Tested by	ED. Lin		
Test Mode	Mode 1		

Antenna Polarity & Test Distance : Horizontal at 3 m								
No	Frequency (MHz)	Emission Level (dBuV/m)	Limit (dBuV/m)	Margin (dB)	Antenna Height (m)	Table Angle (Degree)	Raw Value (dBuV)	Correction Factor (dB/m)
1	1077.15	48.74 QP	54.00	-5.26	1.45 H	152	54.15	-5.41
2	1538.80	46.84 QP	54.00	-7.16	1.03 H	189	51.40	-4.56
3	1607.17	46.93 QP	54.00	-7.07	2.46 H	156	51.24	-4.31
4	1624.30	48.15 QP	54.00	-5.85	2.56 H	156	52.39	-4.24
5	1692.65	47.29 QP	54.00	-6.71	2.17 H	80	51.25	-3.96
6	1778.15	42.39 QP	54.00	-11.61	1.00 H	138	45.97	-3.58

Remarks:

1. Emission Level(dBuV/m) = Raw Value(dBuV) + Correction Factor(dB/m)
2. Correction Factor(dB/m) = Antenna Factor (dB/m) + Cable Factor (dB)
– Pre-Amplifier Factor (dB)
3. The other emission levels were very low against the limit.
4. Margin value = Emission level – Limit value

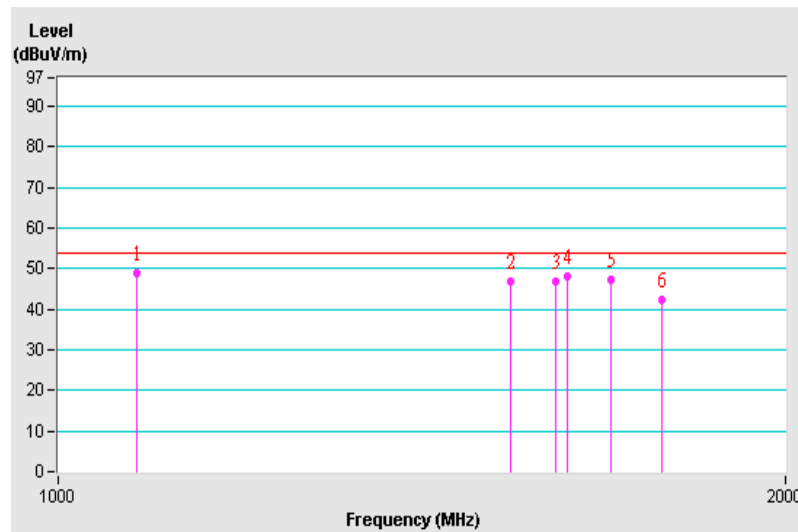

Frequency Range	1GHz ~ 2GHz	Detector Function & Bandwidth	Quasi-Peak (QP), 120kHz
Input Power	24Vdc	Environmental Conditions	20°C, 80%RH
Tested by	ED. Lin		
Test Mode	Mode 1		

Antenna Polarity & Test Distance : Vertical at 3 m								
No	Frequency (MHz)	Emission Level (dBuV/m)	Limit (dBuV/m)	Margin (dB)	Antenna Height (m)	Table Angle (Degree)	Raw Value (dBuV)	Correction Factor (dB/m)
1	1077.15	48.89 QP	54.00	-5.11	2.45 V	53	54.30	-5.41
2	1470.37	44.72 QP	54.00	-9.28	1.02 V	149	49.43	-4.71
3	1538.78	50.81 QP	54.00	-3.19	2.56 V	360	55.37	-4.56
4	1607.17	51.20 QP	54.00	-2.80	1.60 V	336	55.51	-4.31
5	1624.28	51.71 QP	54.00	-2.29	1.44 V	332	55.95	-4.24
6	1692.67	48.16 QP	54.00	-5.84	1.95 V	0	52.12	-3.96

Remarks:

1. Emission Level(dBuV/m) = Raw Value(dBuV) + Correction Factor(dB/m)
2. Correction Factor(dB/m) = Antenna Factor (dB/m) + Cable Factor (dB) – Pre-Amplifier Factor (dB)
3. The other emission levels were very low against the limit.
4. Margin value = Emission level – Limit value

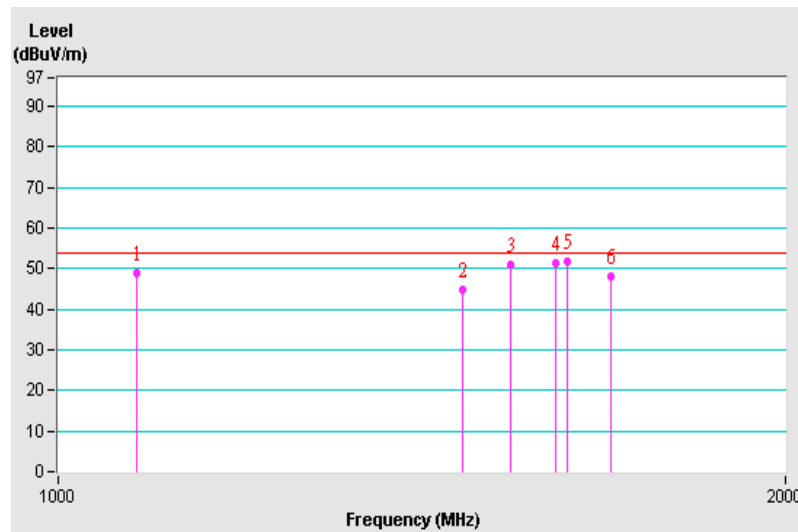

Frequency Range	156MHz ~ 165MHz	Detector Function & Bandwidth	Peak (PK), 9kHz
Input Power	24Vdc	Environmental Conditions	20°C, 80%RH
Tested by	ED. Lin		
Test Mode	Mode 1		

Antenna Polarity & Test Distance : Horizontal at 3 m								
No	Frequency (MHz)	Emission Level (dBuV/m)	Limit (dBuV/m)	Margin (dB)	Antenna Height (m)	Table Angle (Degree)	Raw Value (dBuV)	Correction Factor (dB/m)
1	159.75	25.31 PK	30.00	-4.69	2.04 H	261	38.86	-13.55
2	163.66	26.51 PK	30.00	-3.49	1.82 H	150	40.19	-13.68
3	163.93	27.29 PK	30.00	-2.71	2.12 H	155	40.97	-13.68
4	164.24	26.15 PK	30.00	-3.85	1.96 H	150	39.83	-13.68
5	164.55	26.88 PK	30.00	-3.12	1.30 H	132	40.56	-13.68
6	164.85	26.71 PK	30.00	-3.29	2.12 H	161	40.39	-13.68

Remarks:

1. Emission Level(dBuV/m) = Raw Value(dBuV) + Correction Factor(dB/m)
2. Correction Factor(dB/m) = Antenna Factor (dB/m) + Cable Factor (dB)
– Pre-Amplifier Factor (dB)
3. The other emission levels were very low against the limit.
4. Margin value = Emission level – Limit value

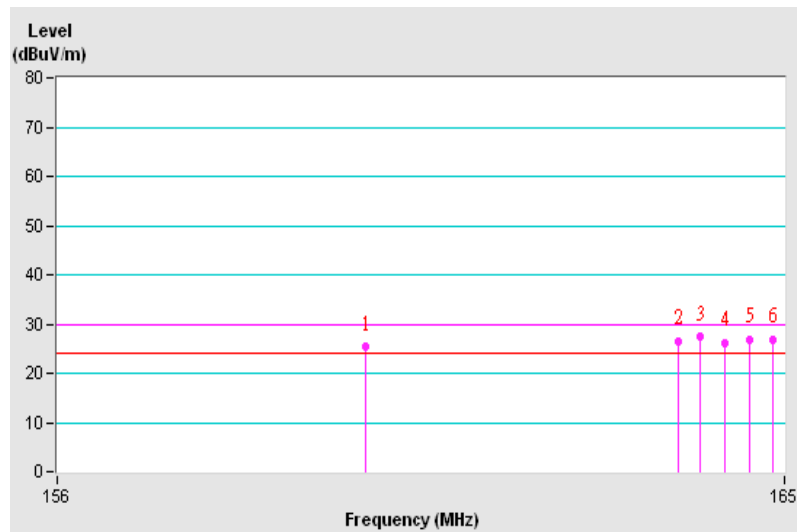

Frequency Range	156MHz ~ 165MHz	Detector Function & Bandwidth	Peak (PK), 9kHz
Input Power	24Vdc	Environmental Conditions	20°C, 80%RH
Tested by	ED. Lin		
Test Mode	Mode 1		

Antenna Polarity & Test Distance : Vertical at 3 m								
No	Frequency (MHz)	Emission Level (dBuV/m)	Limit (dBuV/m)	Margin (dB)	Antenna Height (m)	Table Angle (Degree)	Raw Value (dBuV)	Correction Factor (dB/m)
1	160.00	26.13 PK	30.00	-3.87	1.33 V	355	39.69	-13.56
2	162.70	26.35 PK	30.00	-3.65	1.00 V	360	40.04	-13.69
3	163.00	26.40 PK	30.00	-3.60	1.03 V	23	40.09	-13.69
4	163.31	26.34 PK	30.00	-3.66	2.10 V	14	40.02	-13.68
5	163.90	26.11 PK	30.00	-3.89	1.00 V	360	39.79	-13.68
6	164.22	26.89 PK	30.00	-3.11	1.00 V	11	40.57	-13.68

Remarks:

1. Emission Level(dBuV/m) = Raw Value(dBuV) + Correction Factor(dB/m)
2. Correction Factor(dB/m) = Antenna Factor (dB/m) + Cable Factor (dB)
– Pre-Amplifier Factor (dB)
3. The other emission levels were very low against the limit.
4. Margin value = Emission level – Limit value

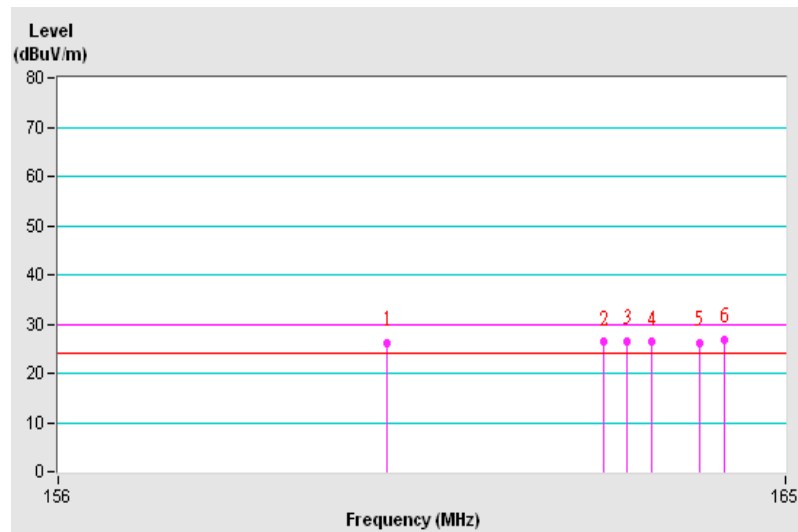

6.5 Performance Criteria

General Performance Criteria

The general performance criteria apply for those ports for which no specific performance criteria are defined (e.g. auxiliary ports) in the report.

- performance criterion A: the EUT shall continue to operate as intended during and after the test. No degradation of performance or loss of function is allowed, as defined in the relevant equipment standard and in the technical specification published by the manufacturer;
- performance criterion B: the EUT shall continue to operate as intended after the test. No degradation of performance or loss of function is allowed, as defined in the relevant equipment standard and in the technical specification published by the manufacturer. During the test, degradation or loss of function or performance which is self-recoverable is however, allowed, but no change of actual operating state or stored data is allowed.
- performance criterion C: temporary degradation or loss of function or performance is allowed during the test, provided the function is self-recoverable, or can be restored at the end of the test by the operation of the controls, as defined in the relevant equipment standard and in the technical specification published by the manufacturer.

7 Immunity to Conducted Radio Frequency disturbance (CS)

7.1 Test Specification

Basic Standard:	IEC 61000-4-6
Frequency Range:	0.15 MHz - 80 MHz
Voltage Level:	a.c. and d.c. power ports, signal and control ports: 3 V rms for frequency range: 150 kHz - 80 MHz 10 V rms at spot frequencies: 2, 3, 4, 6.2, 8.2, 12.6, 16.5, 18.8, 22, and 25 MHz.
Modulation:	400 Hz Sine Wave, 80%, AM Modulation :
Frequency Step:	1 % of preceding frequency value
Dwell Time	3 seconds

7.2 Test Instruments

Description & Manufacturer	Model No.	Serial No.	Cal. Date	Cal. Due
ROHDE & SCHWARZ Signal Generator	SML03	101801	Jan. 6, 2017	Jan. 5, 2018
Digital Sweep Function Generator	8120	984801	NA	NA
AR Power Amplifier	75A250AM1	306331	NA	NA
FCC Coupling Decoupling Network	FCC-801-M2-16A	01047	Jun. 21, 2017	Jun. 20, 2018
FISCHER CUSTOM COMMUNICATIONS EM Injection Clamp	F-203I-23mm	455	NA	NA
FISCHER CUSTOM COMMUNICATIONS Current Injection Clamp	F-120-9A	361	Jul. 26, 2017	Jul. 25, 2018
B&K Ear Simulator	4185	2553594	NA	NA
EM TEST Coupling Decoupling Network	CDN M1/32A	306508	Jun. 21, 2017	Jun. 20, 2018
TESEQ Coupling Decoupling Network	CDN T800	34428	Jun. 21, 2017	Jun. 20, 2018
FCC Coupling Decoupling Network	FCC-801-T4	02031	Jun. 21, 2017	Jun. 20, 2018
EM TEST Coupling Decoupling Network	CDN T2	306509	Jun. 21, 2017	Jun. 20, 2018
R&S Power Sensor	NRV-Z5	837878/039	Oct. 30, 2017	Oct. 29, 2018
R&S Power Meter	NRVD	837794/040	Oct. 30, 2017	Oct. 29, 2018
TESEQ Coupling Decoupling Network	CDN M232	37702	Jun. 21, 2017	Jun. 20, 2018
TESEQ Coupling Decoupling Network	CDN M332	41258	Jun. 21, 2017	Jun. 20, 2018
TESEQ Coupling Decoupling Network	CDN M332	41256	Jun. 21, 2017	Jun. 20, 2018
TESEQ Coupling Decoupling Network	CDN T400A	28569	Jun. 21, 2017	Jun. 20, 2018
TESEQ Coupling Decoupling Network	CDN T8-10	40376	Jun. 21, 2017	Jun. 20, 2018
Software	CS_V7.4.2	NA	NA	NA

- Notes:
1. The calibration interval of the above test instruments is 12 months and the calibrations are traceable to NML/ROC and NIST/USA.
 2. The test was performed in CS Room No. 1.
 3. Tested Date: Jan. 5, 2018

7.3 Test Arrangement

- a. The EUT shall be tested within its intended operating and climatic conditions.
- b. An artificial hand was placed on the hand-held accessory and connected to the ground reference plane.
- c. One of the CDNs not used for injection was terminated with 50 ohm, providing only one return path. All other CDNs were coupled as decoupling networks.
- d. The frequency range is swept from 150 kHz to 80 MHz, using the signal level established during the setting process and with a disturbance signal of 80 % amplitude. The signal is modulated with a 400 Hz sine wave, pausing to adjust the RF signal level or the switch coupling devices as necessary. Where the frequency is swept incrementally, the step size shall not exceed 1 % of the preceding frequency value.
- e. Attempts should be made to fully exercise the EUT during testing, and to fully interrogate all exercise modes selected for susceptibility.
- f. At least one representative cable of each FUNCTION on the ME EQUIPMENT or ME SYSTEM shall be tested.
- g. All patient-coupled cables shall be tested, either individually or bundled.
- h. The power input cable shall be tested.
- i. The POTENTIAL EQUALIZATION CONDUCTOR shall be tested.

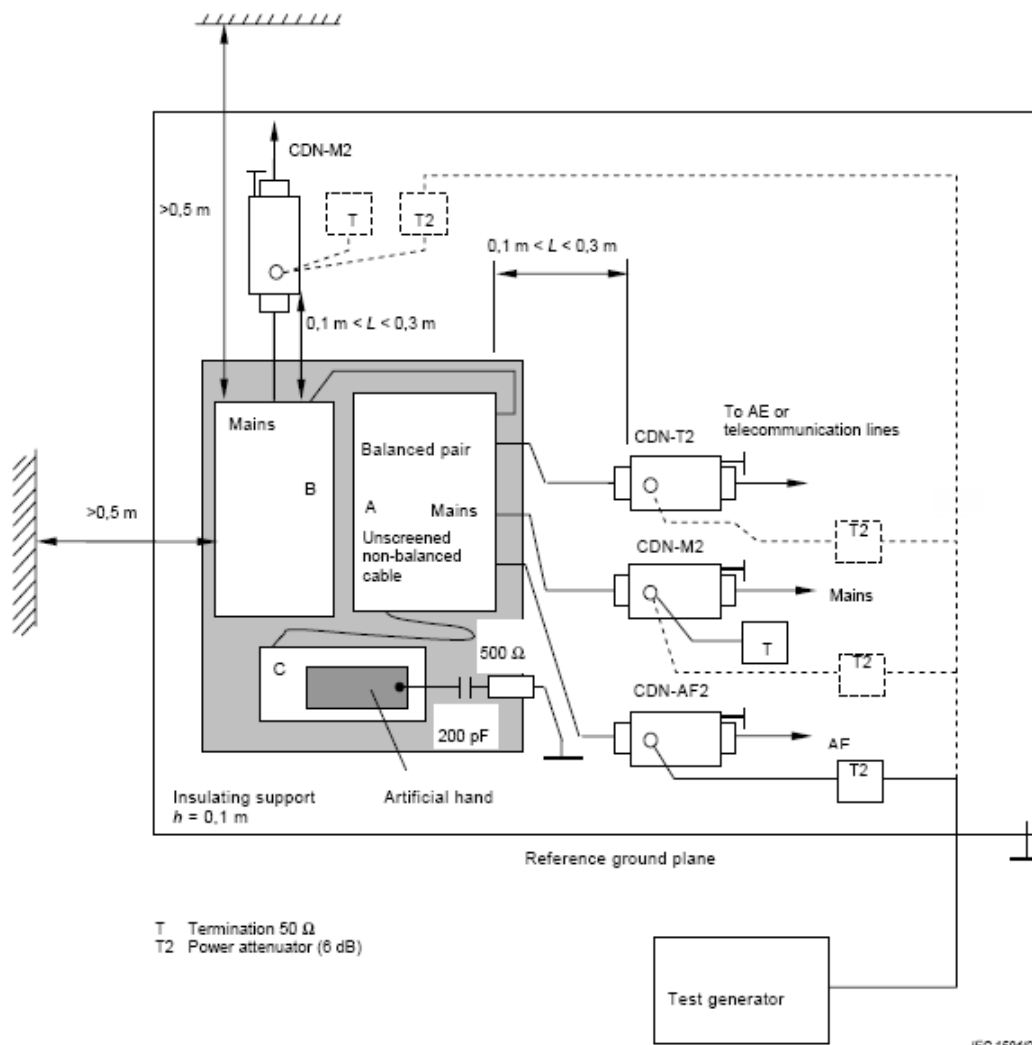

- Note:**
1. The EUT clearance from any metallic obstacles shall be at least 0,5 m.
 2. Interconnecting cables ($\leq 1\text{ m}$) belonging to the EUT shall remain on the insulating support.
 3. The equipment to be tested is placed on an insulating support of 0.1 meters height above a ground reference plane. All relevant cables shall be provided with the appropriate coupling and decoupling devices at a distance between 0.1 meters and 0.3 meters from the projected geometry of the EUT on the ground reference plane.

For the actual test configuration, please refer to the related item – Photographs of the Test Configuration.

7.4 Test Results

Input Power	24Vdc	Tested by	Xun Lee
Environmental Conditions	21°C, 66% RH	Test mode	Mode 1

Frequency (MHz)	Level (V rms)	Tested Line	Injection Method	Return Path	Observation	Remark	Performance Criterion
0.15 – 80	3	DC Main	CDN-M3	CDN-T8	Note	-	A
2, 3, 4, 6.2, 8.2, 12.6, 16.5, 18.8, 22, and 25	10	DC Main	CDN-M3	CDN-T8	Note	-	A
0.15 – 80	3	LAN	CDN-T8	CDN-M3	Note	-	A
2, 3, 4, 6.2, 8.2, 12.6, 16.5, 18.8, 22, and 25	10	LAN	CDN-T8	CDN-M3	Note	-	A

Note: The EUT function was correct during the test.

8 Radiated, Radio-frequency, Electromagnetic Field Immunity Test (RS)

8.1 Test Specification

Basic Standard:	IEC 61000-4-3
Frequency Range, Field Strength:	80MHz-2GHz, 10V/m
Modulation:	400Hz Sine Wave, 80%, AM Modulation
Frequency Step:	1 % of preceding frequency value
Polarity of Antenna:	Horizontal and Vertical
Antenna Height:	1.5m
Dwell Time:	3 seconds for 80MHz-1GHz (1.5×10^{-3} decades/s) 9 seconds for 1GHz-2GHz (0.5×10^{-3} decades/s)

8.2 Test Instruments

Description & Manufacturer	Model No.	Serial No.	Cal. Date	Cal. Due
BOONTON Power Meter	4232A	94901	Jul. 18, 2017	Jul. 17, 2018
BOONTON Power Sensor	51011-EMC	32807	Jul. 18, 2017	Jul. 17, 2018
BOONTON Power Sensor	51011-EMC	32832	Jul. 18, 2017	Jul. 17, 2018
TESEQ RF Generator	ITS 6006	37543	May 8, 2017	May 7, 2018
Narda Broadband Field Meter	NBM-550	B-0872	Feb. 9, 2016	Feb. 8, 2018
TESTQ Amplifier	AS1860-50	S-5944/1	NA	NA
TESTQ Amplifier	CBA 3G-050	T44345	NA	NA
TESTQ Amplifier	CBA 1G-275	T44344	NA	NA
AR Log-Periodic Antenna	AT5080	312115	NA	NA
Schwarzbeck LOG ANTENNA	Stlp 9149	9149-260	NA	NA
CHANCE MOST Compact Full Anechoic Chamber (7x3x3 m)	N/A	N/A	Jul. 28, 2017	Jul. 27, 2018
Software	RS_V7.6	NA	NA	NA

- Notes:
1. The calibration interval of the above test instruments is 12/24 months and the calibrations are traceable to NML/ROC and NIST/USA.
 2. The test was performed in RS Room No.1.
 3. The transmit antenna was located at a distance of 3 meters from the EUT.
 4. Tested Date: Jan. 3, 2018

8.3 Test Arrangement

The test procedure was in accordance with IEC 61000-4-3.

- a. The testing was performed in a fully chamber.
- b. The frequency ranges and field strength levels are 80MHz-2GHz, 10V/m with the signal 80% amplitude modulated with a 400Hz sine wave.
- c. The frequency range shall be swept at a rate in the order of $1,5 \times 10^{-3}$ decades/s for the frequency range 80 MHz to 1 GHz and $0,5 \times 10^{-3}$ decades/s for the frequency range 1 GHz to 2 GHz, and shall be slow enough to allow the detection of any malfunction of the EUT. Any sensitive frequencies or frequencies of dominant interest shall be discretely analyzed.
- d. The test was performed with the EUT exposed to both vertically and horizontally polarized fields on each of the four sides.

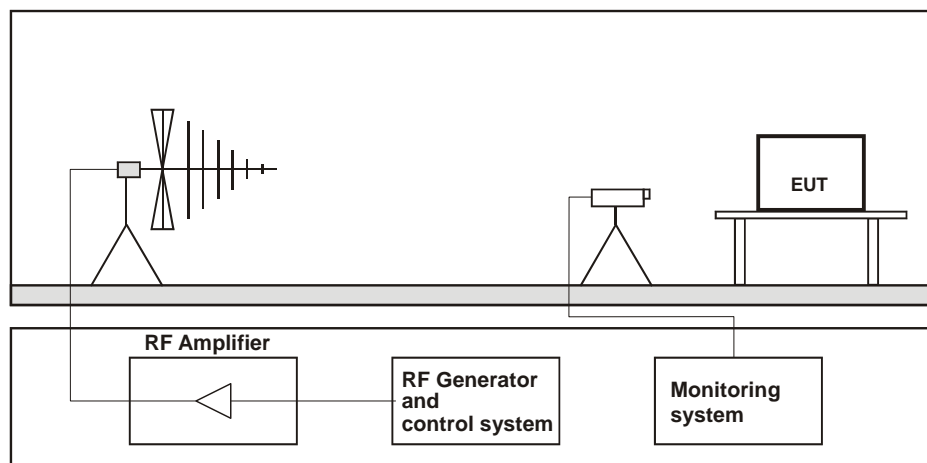

Table-top Equipment

The EUT installed in a representative system as described in section 7 of IEC 61000-4-3 was placed on a non-conductive table 0.8 meters in height. The system under test was connected to the power and signal wire according to relevant installation instructions.

For the actual test configuration, please refer to the related item – Photographs of the Test Configuration.

8.4 Test Results

Input Power	24Vdc	Tested by	Thomas Cheng
Environmental Conditions	24°C, 60% RH	Test mode	Mode 1

Frequency (MHz)	Polarity	Azimuth(°)	Applied Field Strength		Observation	Remarks	Performance Criterion
			(V/m)	Modulation			
80 - 2000	V&H	0, 90, 180, 270	10	80% AM (400Hz)	Note	-	A

Note: The EUT function was correct during the test.

9 Electrical Fast Transient/Burst Immunity Test (EFT)

9.1 Test Specification

Basic Standard:	IEC 61000-4-4
Test Voltage:	N/A, differential on a.c. power lines, coupling/decoupling network ±1kV, common mode on signal and control lines, capacitive coupling clamp
Impulse Repetition Frequency:	5kHz (1kV), 2.5kHz (2kV)
Impulse Wave Shape:	5/50 (T _r /T _h) ns
Burst Duration:	15 ms
Burst Period:	300 ms
Test Duration:	5 min

9.2 Test Instruments

Description & Manufacturer	Model No.	Serial No.	Cal. Date	Cal. Due
Haefely, EFT Generator	PEFT 4010	154954	Apr. 17, 2017	Apr. 16, 2018
Haefely, Capacitive Clamp	IP4A	155173	Apr. 17, 2017	Apr. 16, 2018

- Notes:
1. The calibration interval of the above test instruments is 12 months and the calibrations are traceable to NML/ROC and NIST/USA.
 2. The test was performed in EFT Room.
 3. Tested Date: Jan. 3, 2018

9.3 Test Arrangement

- Both positive and negative polarity discharges were applied.
- The distance between any coupling devices and the EUT should be 0.5 m for table-top equipment testing, and 1.0 m for floor standing equipment.
- The duration time of each test sequential was 5 minutes.
- The transient/burst waveform was in accordance with IEC 61000-4-4, 5/50 ns.

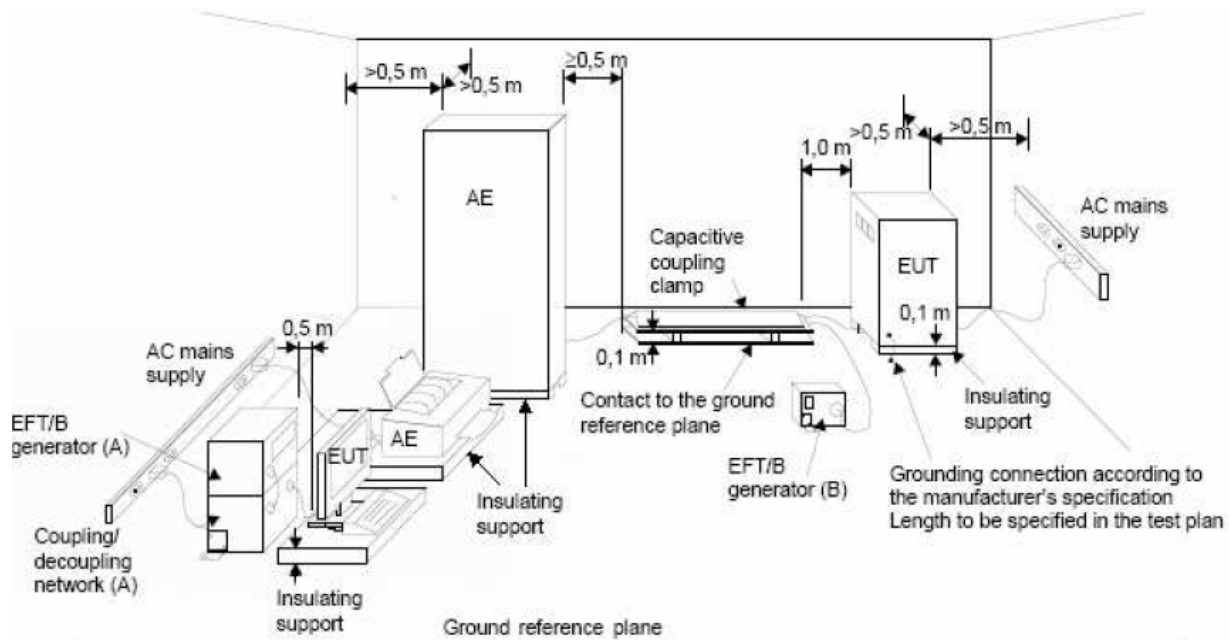

NOTE:

- location for supply line coupling
- location for signal lines coupling

For the actual test configuration, please refer to the related item – Photographs of the Test Configuration.

9.4 Test Results

Input Power	24Vdc	Tested by	Chiming Li
Environmental Conditions	22°C, 66% RH	Test mode	Mode 1

Signal and control lines

Voltage (kV)	Repetition rate (kHz)	Test Point	Polarity (+/-)	Observation	Performance Criterion
1	5	LAN	+/-	Note	A

Note: The EUT function was correct during the test.

10 Power supply failure

10.1 Test Specification

Basic Standard:	IEC 61000-4-11
Test levels:	voltage residual, 0 %
Test Duration Time:	60 s each
Sync Angle (degrees):	0° / 180°
Test Cycle:	3 times

10.2 Test Instruments

Description & Manufacturer	Model No.	Serial No.	Cal. Date	Cal. Due
Teseq Immunity Test System	Proflin 2145	1323A03998	Jan. 06, 2017	Jan. 05, 2018
Software	WIN2145	NA	NA	NA

- Notes:
1. The calibration interval of the above test instruments is 24 months and the calibrations are traceable to NML/ROC and NIST/USA.
 2. The test was performed in EMS Room No. 2.
 3. Tested Date: Jan. 3, 2018

10.3 Test Arrangement

The EUT shall be tested for each selected combination of test levels and duration with three breaks in power supply of duration 60 s each. Each representative mode of operation shall be tested. Abrupt changes in supply voltage shall occur at 0 degree crossover point of the voltage waveform.

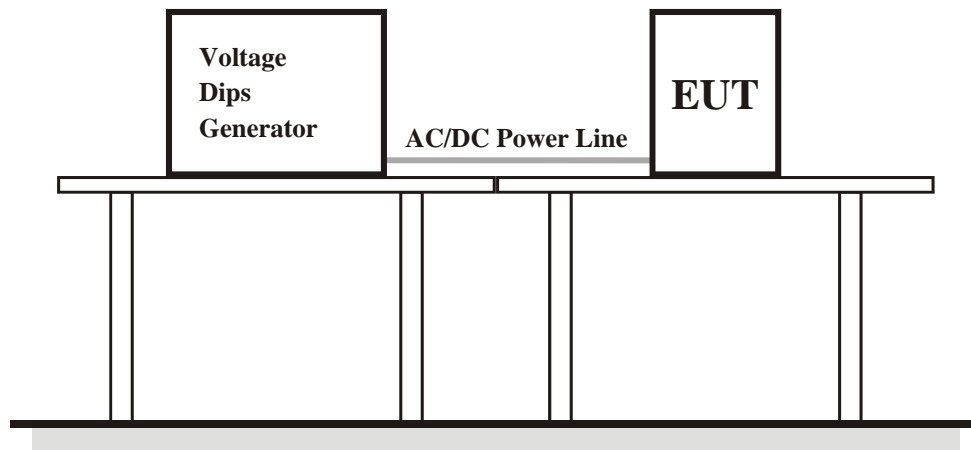

For the actual test configuration, please refer to the related item – Photographs of the Test Configuration.

10.4 Test Results

Input Power	24Vdc	Tested by	Thomas Cheng
Environmental Conditions	20°C, 58% RH	Test mode	Mode 1

Input Power for testing: 24Vdc				
Voltage Residual (%)	Duration (seconds)	Times	Observation	Performance Criterion
0	60	3	Note	C

Note: The EUT shut down but could be restored by the operator.

11 Electrostatic Discharge Immunity Test (ESD)

11.1 Test Specification

Basic Standard:	IEC 61000-4-2
Discharge Impedance:	330 ohm / 150 pF
Discharge Voltage:	Air Discharge: $\pm 2, \pm 4, \pm 8$ kV (Direct) Contact Discharge: $\pm 2, \pm 4$ kV, ± 6 kV (Direct & Indirect)
Number of Discharge:	Minimum 20 times at each test point
Discharge Mode:	Single Discharge
Discharge Period:	1 second minimum

11.2 Test Instruments

Description & Manufacturer	Model No.	Serial No.	Cal. Date	Cal. Due
EM Test ESD Simulator	Dito	V0707102251	Apr. 11, 2017	Apr. 10, 2018

- Notes:
1. The calibration interval of the above test instruments is 12 months and the calibrations are traceable to NML/ROC and NIST/USA.
 2. The test was performed in ESD Room No. 2.
 3. Tested Date: Jan. 3, 2018

11.3 Test Arrangement

- Electrostatic discharges were applied only to those points and surfaces of the EUT that are accessible to users during normal operation.
- The test was performed with at least ten single discharges on the pre-selected points in the most sensitive polarity.
- The time interval between two successive single discharges was at least 1 second.
- The ESD generator was held perpendicularly to the surface to which the discharge was applied and the return cable was at least 0.2 meters from the EUT.
- Contact discharges were applied to the non-insulating coating, with the pointed tip of the generator penetrating the coating and contacting the conducting substrate.
- Air discharges were applied with the round discharge tip of the discharge electrode approaching the EUT as fast as possible (without causing mechanical damage) to touch the EUT. After each discharge, the ESD generator was removed from the EUT and re-triggered for a new single discharge. The test was repeated until all discharges were complete.
- At least ten single discharges (in the most sensitive polarity) were applied to the **Horizontal Coupling Plane** at points on each side of the EUT. The ESD generator was positioned at a distance of 0.1 meters from the EUT with the discharge electrode touching the **HCP**.
- At least ten single discharges (in the most sensitive polarity) were applied to the center of one vertical edge of the **Vertical Coupling Plane** in sufficiently different positions that the four faces of the EUT were completely illuminated. The **VCP** (dimensions 0.5m x 0.5m) was placed vertically to and 0.1 meters from the EUT.

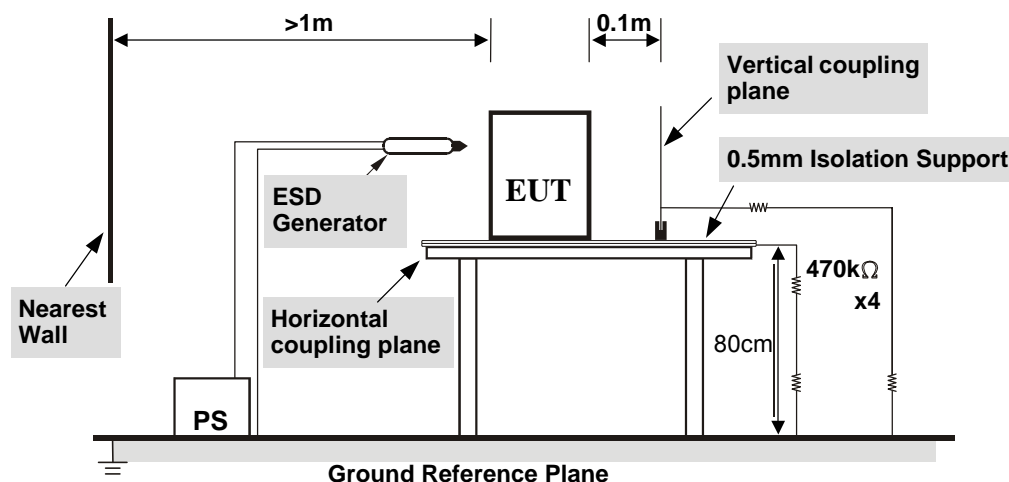

TABLE-TOP EQUIPMENT

The configuration consisted of a wooden table 0.8 meters high standing on the **Ground Reference Plane**. The **GRP** consisted of a sheet of aluminum at least 0.25mm thick, and 2.5 meters square connected to the protective grounding system. A **Horizontal Coupling Plane** (1.6m x 0.8m) was placed on the table and attached to the **GRP** by means of a cable with $940\text{k}\Omega$ total impedance. The equipment under test, was installed in a representative system as described in section 7 of IEC 61000-4-2, and its cables were placed on the **HCP** and isolated by an insulating support of 0.5mm thickness. A distance of 1-meter minimum was provided between the EUT and the walls of the laboratory and any other metallic structure.

For the actual test configuration, please refer to the related item – Photographs of the Test Configuration.

11.4 Test Results

Input Power	24Vdc	Tested by	Thomas Cheng
Environmental Conditions	24°C, 42% RH 1002 mbar	Test mode	Mode 1

Test Results of Direct Application

Discharge Level (kV)	Polarity (+/-)	Test Point	Contact Discharge	Air Discharge	Performance Criterion
2	+/-	1-3	Note 1	NA	A
4, 6	+/-	1-3	Note 2	NA	B
2, 4	+/-	4-11	NA	Note 1	A
8	+/-	4-11	NA	Note 2	B

Description of test points of direct application: Please refer to following page for representative mark only.

Test Results of Indirect Application

Discharge Level (kV)	Polarity (+/-)	Test Point	Horizontal Coupling Plane	Vertical Coupling Plane	Performance Criterion
2, 4	+/-	Four Sides	Note 1	Note 1	A
6	+/-	Four Sides	Note 2	Note 2	B

Description of test points of indirect application:

1. Front side 2. Rear side 3. Right side 4. Left side

- Note: 1. The EUT function was correct during the test.
 2. There was flicker disturbance on the external monitor during the test, but self-recoverable after the test.

Description of Test Points

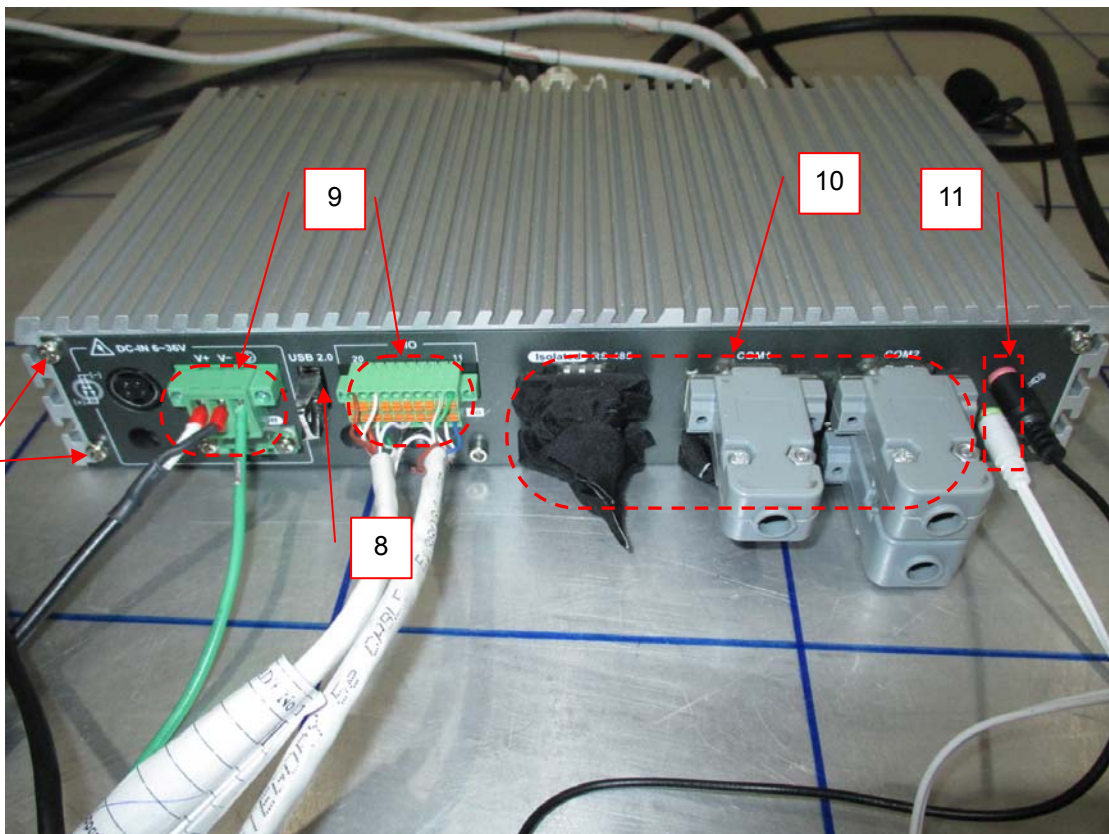
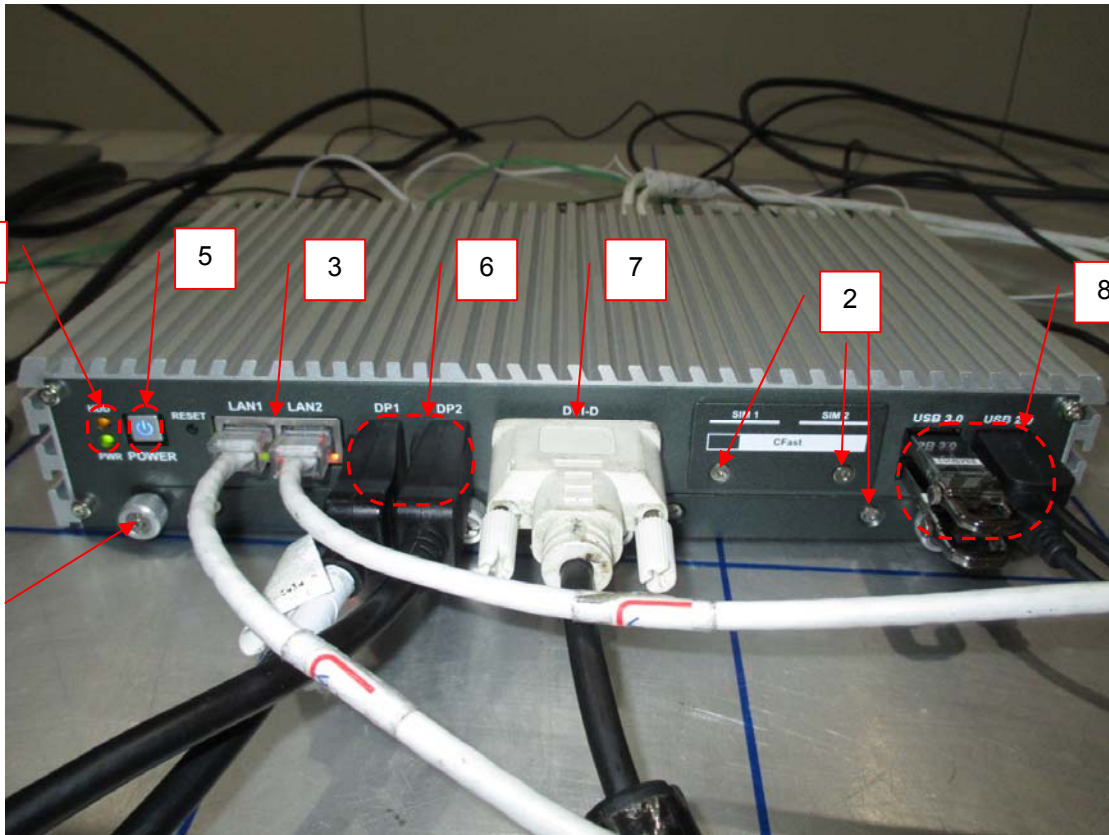

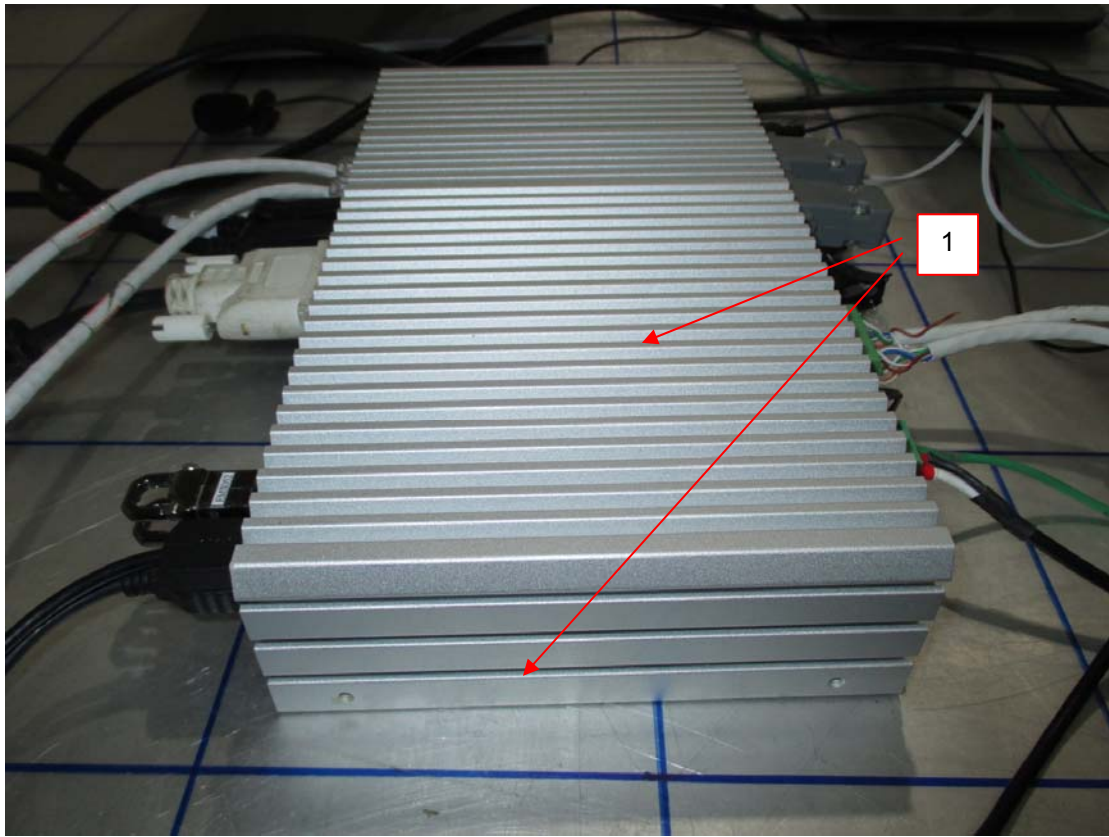

12 Pictures of Test Arrangements

12.1 Conducted Emissions



12.2 Radiated Emissions

Frequency Range below 1000 MHz

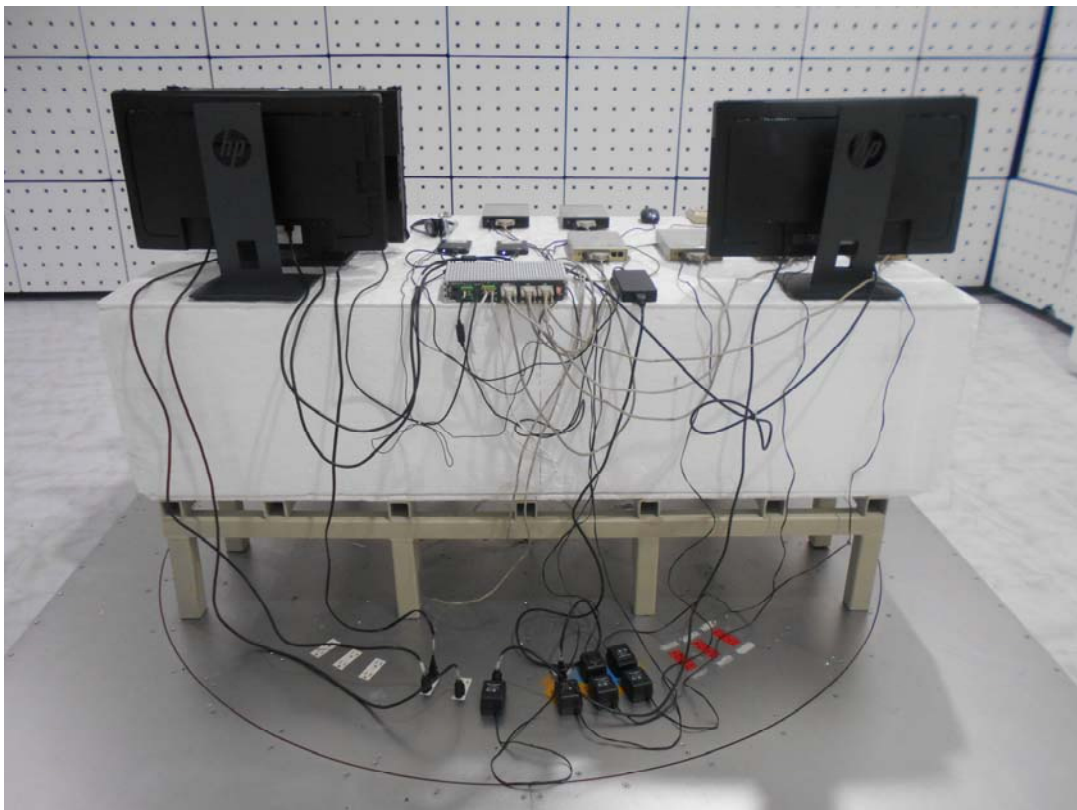

Frequency Range above 1000 MHz

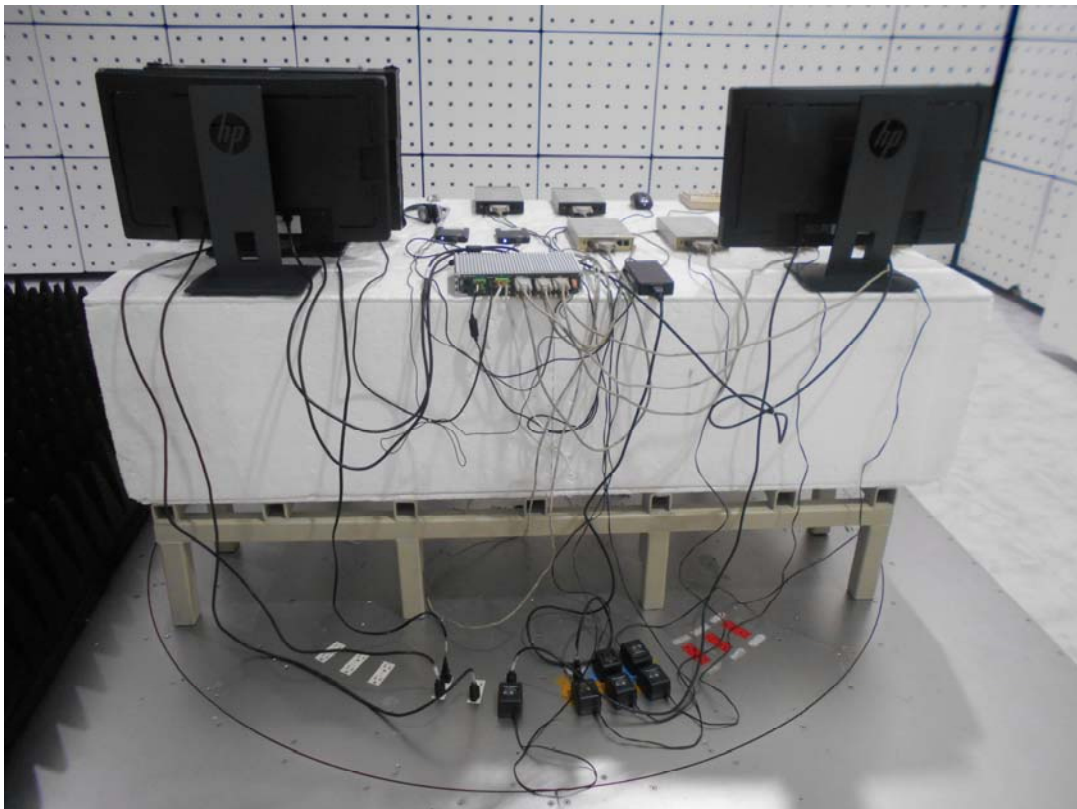

12.3 Conducted Radio Frequency Disturbance (CS)

Mains ports

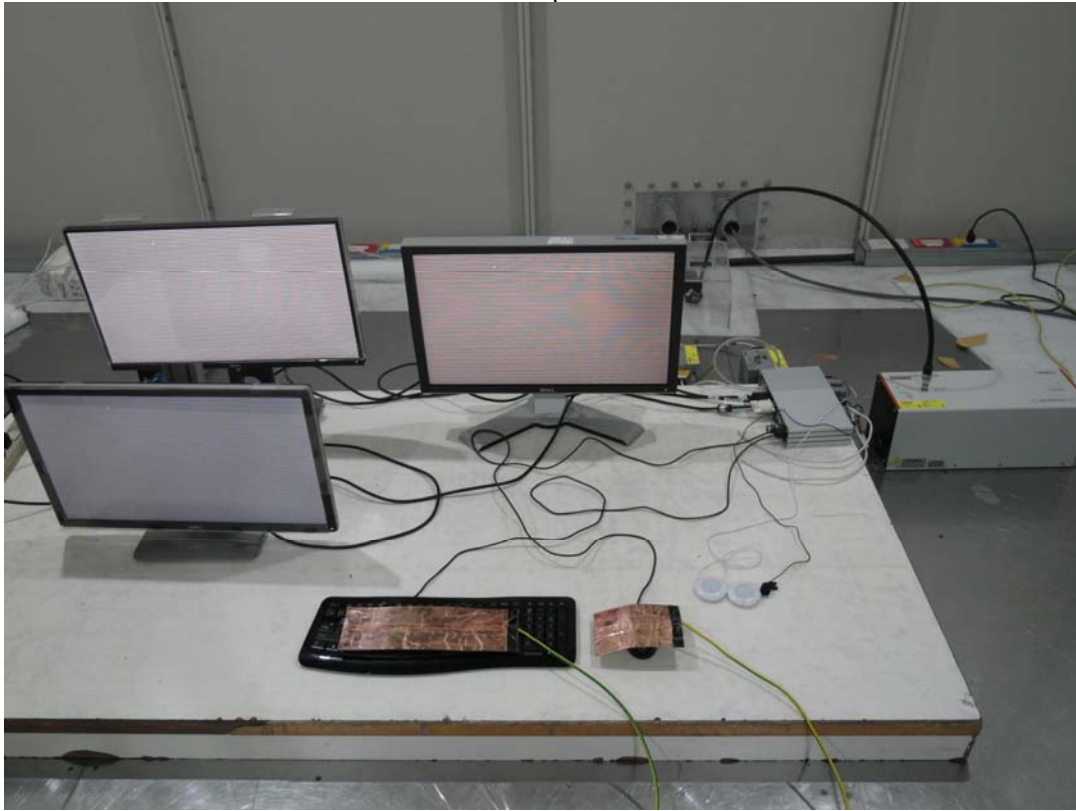

LAN

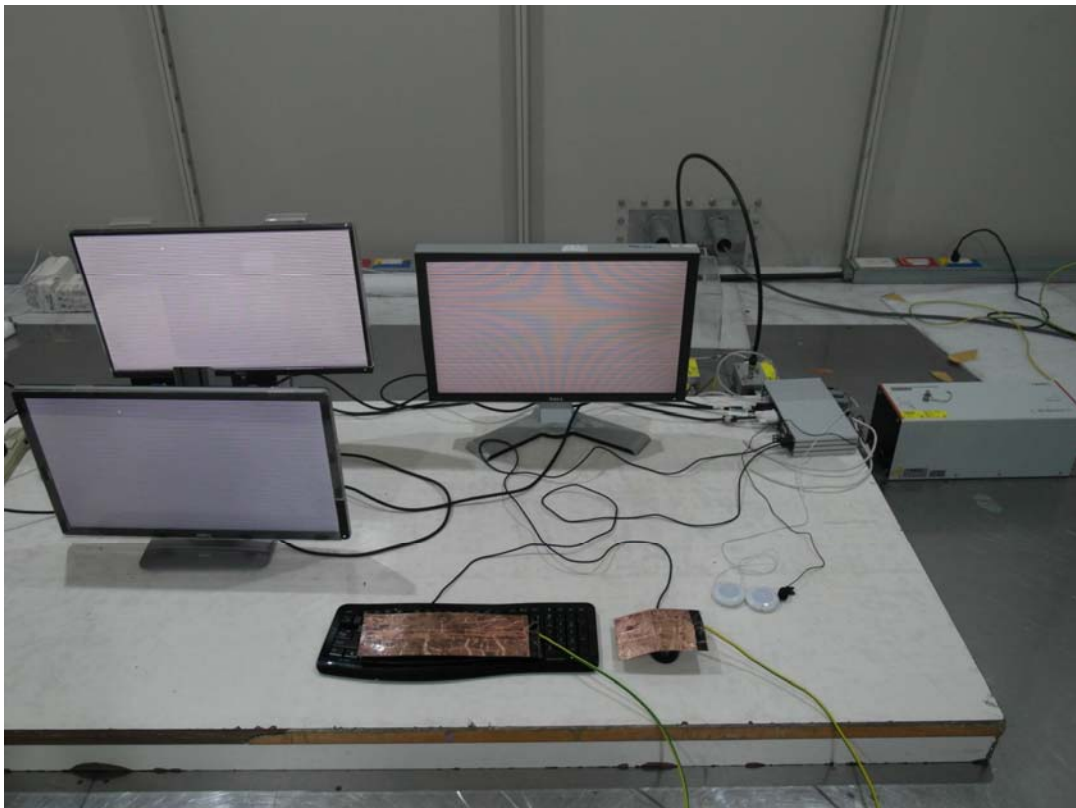

12.4 Radiated disturbance (RS)

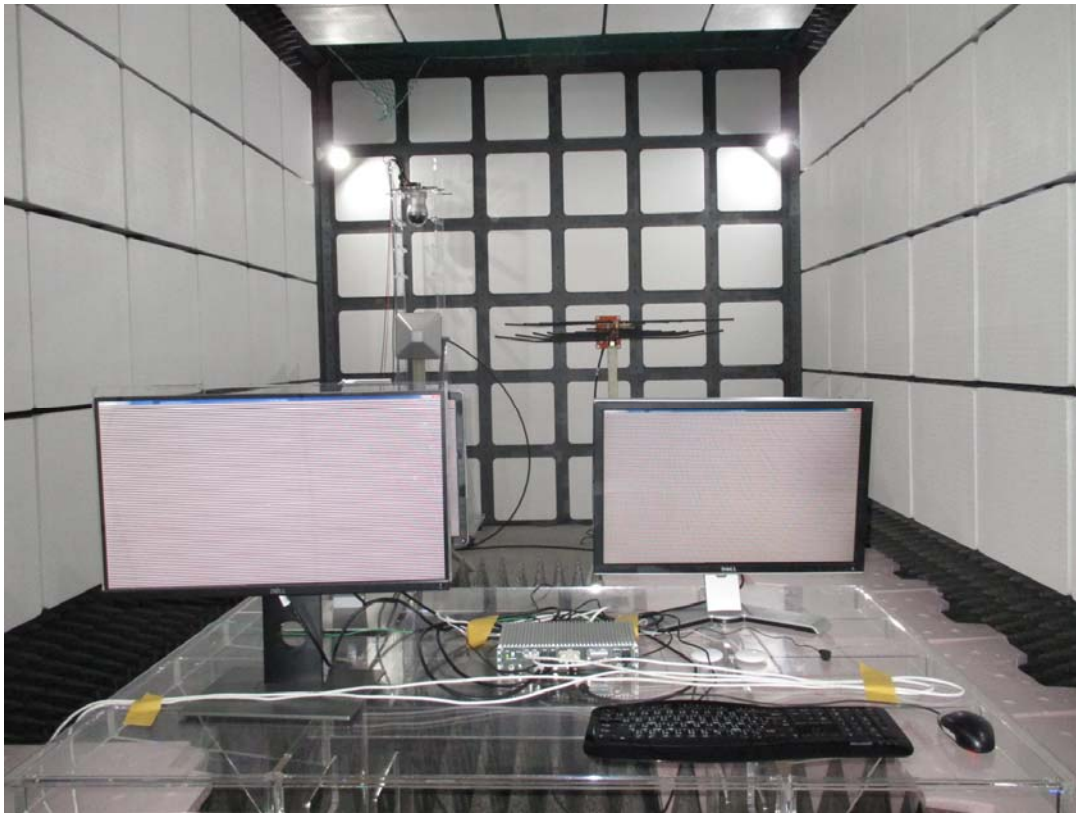

12.5 Burst / Fast Transient (EFT)

LAN



12.6 Power supply failure



12.7 Electrostatic Discharge Immunity Test (ESD)



Appendix – Information on the Testing Laboratories

We, Bureau Veritas Consumer Products Services (H.K.) Ltd., Taoyuan Branch, were founded in 1988 to provide our best service in EMC, Radio, Telecom and Safety consultation. Our laboratories are accredited and approved according to ISO/IEC 17025.

If you have any comments, please feel free to contact us at the following:

Linko EMC/RF Lab

Tel: 886-2-26052180

Fax: 886-2-26051924

Hsin Chu EMC/RF/Telecom Lab

Tel: 886-3-6668565

Fax: 886-3-6668323

Hwa Ya EMC/RF/Safety Lab

Tel: 886-3-3183232

Fax: 886-3-3270892

Email: service.adt@tw.bureauveritas.com

Web Site: www.bureauveritas-adt.com

The address and road map of all our labs can be found in our web site also.

--- END ---